

Technical thinking.
Traditional feeling.



Simbología.

Iconography. Iconographie. Иконография.

	Antibacteriano (eficacia del 99.9% Según norma JIS Z 2801:2010) · Antibacterial (efficiency of 99.9% According to JIS Z 2801:2010 standard) · Antibacterien (efficacité de 99,9% selon la norme JIS Z 2801:2010) · Антибактериальные (эффективность 99,9% в соответствии со Стандартом JIS Z 2801:2010)		Impresión digital · Digital printing · Impression numérique · Цифровая печать
	Resistencia al deslizamiento (rampa pie calzado) · Anti-slip resistance (shod ramp) · Résistance au glissement (pied chaussé) · Сопротивление скольжению (если ходит обутым)		Dorso estriado en cola de milano · Dove tail profile · Façonnage en queue d'aronde au dos des carreaux · Ласточкин хвост» на задней стороне плитк
	Resistencia al deslizamiento (rampa pie descalzo) · Anti-slip resistance (barefoot ramp) · Résistance au glissement (rampé pied nu) · Сопротивление скольжению (босые ноги)		Relieve superficial · Superficial relief · Relief superficiel · Рельефная поверхность
	Resistencia al deslizamiento (péndulo) · Anti-slip resistance (pendulum) · Résistance au glissement (pendule) · Сопротивление скольжению (маятник)		Rectificado · Rectified · Carrelage rectifié · Ректифицированная плитка
	Resistencia a la flexión · Modulus of rupture · Résistance à la flexion · Сопротивление на изгиб		Diseño 3D · 3D design · Design 3D · Дизайн 3D
	Resistencia al cuarteo · Cracking resistance · Résistance au tressailage · Устойчивость к растрескиванию		No rejuntar - no pegar · Do not grout - do not glue · Ne pas jointoyer - ne pas coller · Не затирать - не клеить
	Absorción de agua · Water absorption · Absortion d'eau · Водопоглощение		Ligera variación en tonalidad y gráficas · Slight variation in shade and graphics · Légère variation de la teinte et des graphiques · Небольшое различие в оттенках и рисунках
	Resistencia a los agentes químicos · Chemical resistance · Résistance aux produits chimiques · Стойкость к воздействию химикатов		Moderada variación en tonalidad y gráficas · Moderate variation in shade and graphics · Variation modérée de la teinte et des graphiques · Среднее различие в оттенках и рисунках
	Resistencia a la helada · Frost resistance · Résistance au gel · Морозостойкость		Contraste de tonalidad y variedad de gráficas · Contrast in shade and variety of graphics · Contraste de teinte et variété de graphiques · Контрастные оттенки и разнообразие рисунков

Index.

Index. Table. Индекс.

SIMBOLOGÍA. Iconography. Iconographie. Иконография.	2	ÁREA TÉCNICA. Technical area. Zone technique. Техническая область.	266
SOBRE NOSOTROS. About us. À propos de nous. О компании.	4	ESQUEMAS DE COLOCACIÓN MF. MF placement schemes. Schémas de placement MF. Схемы размещения MF.	268
ÍNDICE TIPOLOGÍAS Typologies index. Index des typologies. Указатель типологий.	12	SOLUCIONES TÉCNICAS: ESCALERAS. Technical solutions: stairs. Solutions techniques: escaliers. Технические решения: лестницы.	270
ÍNDICE FORMATOS Formats index. Index des formats. Указатель форматов.	14	SOLUCIONES TÉCNICAS: MUROS. Technical solutions: Walls. Solutions techniques: Murs. Технические решения: стены.	278
ÍNDICE PIEZAS PISCINAS Pool pieces index. Index des pièces de piscine. Указатель деталей плавательных бассейнов.	16	SOLUCIONES TÉCNICAS: PISCINAS. Technical solutions: swimming pools. Solutions techniques : piscines. Технические решения: бассейны.	280
ÍNDICE ACABADOS Finishes index. Indice de finitions. финишный индекс.	17	RECOMENDACIONES DE COLOCACIÓN Y LIMPIEZA. Recommendations for installation and cleaning. Recommandations pour l'installation et le nettoyage. Рекомендации по установке и очистке.	312
SERIES. Collections. Séries. Серииес.	18	PROCESO DE EXTRUSIÓN. Extrusion process. Processus d'extrusion. Процесс экструзии.	316
Series Marble	18	CARACTERÍSTICAS TÉCNICAS. Technical features. Caractéristiques techniques. Технические характеристики.	318
Series Wood	68	LISTA DE EMBALAJE. Packing list. Liste d'emballage. Упаковочный лист.	326
Series Urban	104		
Series Stone	142		
Series Earth	224		
Series Metal	262		

Empresa.

Company. Enterprise. Компания.

A principios de los años 70, EXAGRES se introduce en el mercado del extruido. Desde su fundación, la empresa desempeña un papel fundamental de liderazgo en la investigación de materias primas y procesos productivos, poniendo al alcance de grandes profesionales, soluciones en la aplicación cerámica, desarrollando piezas especiales como peldaños, esquinas, ángulos, vierteaguas, bordes de piscinas, etc. que posicionan a Exagres, como líder en la fabricación en Europa.

Esta Innovación y Desarrollo se traslada al mercado en voz de un equipo con talento, cercano y a la escucha de cada una de las necesidades de clientes y profesionales. En la actualidad, Exagres se afianza, con la seguridad de más de 40 años de innovación tecnológica, conocimiento y entendimiento de múltiples necesidades para lograr productos de calidad y crear valor añadido a través una cultura de gestión integral y mejora continua, fundamentada en la calidad del servicio y producto, la protección ambiental, la seguridad y salud de las personas que forman parte de nuestra empresa.

At the beginning of the 70s, EXAGRES broke into the market of extruded products. Since it was founded, the company has played a fundamental role in the leadership in the research of raw materials and production processes, providing solutions for ceramic applications in the hands of great professionals, developing special pieces such as step treads, corners, angles, gutters, pool copings, etc. these facts position Exagres as a leading manufacturer in Europe. Innovation and development are transferred to the market through the voice of a talented, friendly team that is capable to listen to each of the needs of their customers and professionals. Currently, Exagres is strengthened of 40 years of technological innovation, knowledge and understanding of multiple needs in order to achieve quality products, creating added value through a culture of integral management and continuous improvement, based on the quality of the service and product, environmental protection and the health and safety of the people who form part of our company.

Au début des années 70, EXAGRES pénètre dans le marché de l'extrusion. Depuis sa fondation, l'entreprise remplit un rôle essentiel de leadership dans la recherche de matières premières et processus de production, mettant à la portée des grands professionnels des solutions dans l'application céramique, en développant des pièces spéciales telles que des marches, des coins, des angles, des revingots, des rebords de piscines, etc., qui placent Exagres à la tête de la fabrication en Europe. Cependant, cette innovation et ce développement sont transférés au marché au nom d'une équipe talentueuse, proche et à l'écoute de chacune des nécessités de clients et professionnels. À présent, Exagres se consolide, avec la sécurité de 40 ans d'innovation technologique, connaissance et compréhension de nécessités multiples pour obtenir des produits de qualité et créer de la valeur ajoutée à travers une culture de gestion intégrale et amélioration continue, qui se fonde sur la qualité du service et du produit, la protection environnementale, la sécurité et la santé des personnes qui font partie de notre entreprise.

Компания EXAGRES начала свою деятельность на рынке экструдированной керамики в начале 70-х годов. С момента своего основания она стала одним из лидеров в научных исследованиях в области первичного сырья и производственных процессов, занимая ведущую позицию среди производителей в Европе. Exagres предлагает профессионалам различные решения в области применения керамики, в том числе специальные элементы: ступени, внутренние и внешние углы, водостоки, бортики бассейнов и др. Инновации и опытные разработки осуществляет команда талантливых сотрудников, которые внимательно относятся к мнению клиентов и профессионалов, стремясь удовлетворять все их потребности. Exagres имеет 40-летний опыт в области технологических инноваций. Ее персонал располагает обширными знаниями, в том числе о различных потребностях и запросах, что позволяет создавать высококачественные продукты с дополнительной ценностью. В компании существует особая культура комплексного менеджмента и постоянного совершенствования, основанная на качестве услуг и продукции, защите окружающей среды, а также на обеспечении безопасности и охране здоровья трудящихся.

What we are.

Technical thinking.
Traditional feeling.



Producto.

Product. Produit. Продукты.

Las exigencias en arquitectura varían con el paso de los años, por ello, EXAGRES propone soluciones y superficies que garantizan altos niveles de prestaciones técnicas y estéticas a la vez que respetan las necesidades de la construcción.

El producto de Exagres, con su particular sistema de fabricación, la extrusión, es capaz de generar diferentes formatos y tipos de piezas especiales, todo ello, facilitando su colocación al profesional.

Las series de Exagres garantizan funcionalidad y un alto contenido estético en cada tipo de proyecto. Desde la arquitectura urbana, el uso industrial e incluso en la realización de todo tipo de diseños de carácter residencial en interiores, exteriores y recubrimiento de piscinas.

The requirements of architecture vary over time, Therefore, EXAGRES proposes solutions and surfaces that guarantee high levels of technical and aesthetic qualities while also respecting the needs of the construction.

The Exagres product, with its unique manufacturing system, extrusion, is capable of generating different formats and types of special pieces, thus facilitating installation by a professional.

Exagres collections guarantee functionality and a high aesthetic content in each type of project. From urban architecture, industrial use and even use in all types of designs of a residential nature for interiors, exteriors and swimming pool tiling.

Les exigences en architecture varient au fil des années. De ce fait, EXAGRES propose des solutions et des surfaces qui garantissent de hauts niveaux de prestations techniques et esthétiques en respectant en même temps les nécessités de la construction.

Le produit d'Exagres, avec son système particulier de fabrication, l'extrusion, est capable de générer plusieurs formats et types de pièces spéciales, le tout en facilitant sa pose au professionnel.

Les séries d'Exagres garantissent la fonctionnalité et une haute teneur esthétique dans chaque type de projet. Depuis l'architecture urbaine, l'utilisation industrielle et même dans la réalisation de toute sorte de conceptions à caractère résidentiel en intérieur, extérieur et recouvrement de piscines.

С течением времени требования, предъявляемые к различным материалам в архитектуре, варьируются. Поэтому EXAGRES предлагает решения, которые не только гарантируют высокий уровень технических и эстетических характеристик, но также обеспечивают соответствие потребностям строительства.

Продукты компании Exagres производятся с помощью особой технологии- экструзии, которая позволяет создавать различные форматы и элементы разных форм, что облегчает процесс укладки.

Серии Exagres гарантируют функциональность и прекрасные эстетические характеристики для каждого типа проекта, включая городскую архитектуру, промышленное использование, интерьеры и наружные пространства всевозможных жилых домов, а также покрытия для бассейнов.



What we do.

Extruded porcelain.
Stoneware pieces.



Certificaciones.

Certificates. Certificats. Сертификаты.



Declaración ambiental de producto.
Environmental product declaration.
Déclaration environnementale de produit.
Экологическая декларация продукции.



Sello de reducción de huella de carbono.
Carbon footprint reduction label.
Label de réduction de l'empreinte carbone.
маркировка сокращения выбросов углекислого газа.



A.A.I. Certificado Autorización Ambiental Integrada.
Integrated Environmental Authorisation Certificate.
Certificat d'autorisation environnementale intégrée.
Интегрированное свидетельство об экологическом авторизации.



ISO 9001: 2015
Sistemas de gestión de la calidad.
Quality management systems.
Systèmes de gestion de la qualité.
Системы менеджмента качества.



ISO 14001: 2015
Sistemas de gestión medioambiental.
Environmental management systems.
Systèmes de gestion environnementale.
Системы экологического менеджмента.



ISO 45001: 2018
Sistemas de gestión de la seguridad y salud en el trabajo.
Occupational Health and Safety management systems.
Systèmes de gestion de la santé et de la sécurité au travail.
Системы управления охраной труда и промышленной безопасностью.

En Exagres somos responsables con el medio ambiente. Además utilizamos las herramientas de gestión adecuadas para garantizar la calidad, la protección del medio ambiente, la seguridad y la salud. Desde Exagres aplicamos una política sostenible en todos los procesos productivos, cumpliendo estrictamente todos los parámetros medioambientales a través del desarrollo de técnicas cada vez más eficientes y menos contaminantes.

Chez Exagres nous sommes responsables de l'environnement. Pour cette raison, nous utilisons les outils de gestion adaptés afin de garantir la qualité, l'environnement, la sécurité et la santé. Chez Exagres, nous appliquons une politique durable dans tous nos processus de production, en respectant strictement tous les paramètres environnementaux grâce au développement de techniques toujours plus efficaces et moins polluantes.

At Exagres we are environmentally responsible. For this reason we use the appropriate management tools to guarantee quality, environment, safety and health. At Exagres we have implemented a sustainability policy in all our production processes, strictly meeting all environmental regulations through the development of increasingly efficient and less polluting techniques.

В Exagres мы ответственно относимся к охране окружающей среды. Именно поэтому мы используем инструменты управления, обеспечивающие высокое качество продукции, защиту окружающей среды, безопасность и охрану здоровья. В компании Exagres мы применяем политику устойчивого развития во всех производственных процессах, строго соблюдая все экологические параметры благодаря разработке все более эффективных и менее загрязняющих окружающую среду технологий.

What we love.

Environmentally friendly production & management.



Reconocimientos y premios.

Recognitions & Awards. Reconnaissances et prix . Признания и награды.

La Confederación Española de la Pequeña y Mediana Empresa (CEPYME) ha seleccionado a Exagres como una de las 500 empresas que lideran el crecimiento empresarial, tanto por sus resultados obtenidos en los últimos años, como por su capacidad para generar actividad y empleo, su potencial de innovación y su proyección internacional.

The Spanish Confederation of Small and Medium-Size Enterprises (CEPYME) has chosen Exagres as one of the 500 companies that lead business growth due to its results obtained in recent years, the ability to generate activity and employment, its potential of innovation and international projection.

La Confederation Espagnole de la petite et moyenne entreprise (CEPYME) a sélectionné a Exagres comme l'une de 500 entreprises qui mènent la croissance entrepreneuriale tant per ses excellents résultats obtenus dans les dernières années, que pour sa capacité pour générer activité et emploi, son potentiel d'innovation et sa projection internationale.



Согласно исследованиям Испанской Конфедерации Малых и Средних Предприятий (CEPYME), Exagres вошла в рейтинг 500 быстрорастущих керамических производителей, как за результатами предыдущего года, так и способностью генерировать занятость, потенциал инноваций и международную деятельность.

El camino emprendido por Exagres hacia una fabricación, diseño y filosofía más sostenible, ha obtenido un premio por parte de Archiproducts, una de las plataformas de arquitectura más importantes. Exagres ha sido galardonado con el premio Sostenibilidad 2022 en la categoría Finishes gracias a Exadeck, una exclusiva tarima cerámica, por su innovador concepto, calidad de diseño y, sobre todo, su sostenibilidad como material constructivo.

The path taken by Exagres towards a more sustainable manufacturing, design and philosophy has won an award from Archiproducts, one of the most important architectural platforms. Exagres has been awarded the Sustainability 2022 prize in the Finishes category thanks to Exadeck, an exclusive ceramic decking, for its innovative concept, design quality and, above all, its sustainability as a building material.

Le chemin parcouru par Exagres vers une fabrication, une conception et une philosophie plus durables a été récompensé par Archiproducts, l'une des plus importantes plateformes d'architecture. Exagres a reçu le prix Sustainability 2022 dans la catégorie Finishes pour Exadeck, un revêtement de sol céramique exclusif, pour son concept innovant, sa qualité de conception et, surtout, sa durabilité en tant que matériau de construction.



Путь, пройденный компанией Exagres в направлении более экологичного производства, дизайна и философии, получил награду от Archiproducts, одной из самых важных архитектурных платформ. Компания Exagres была удостоена премии Sustainability 2022 в категории "Отделка" за Exadeck, эксклюзивное керамическое напольное покрытие, за его инновационную концепцию, качество дизайна и, прежде всего, экологичность как строительного материала.

Librería BIM.

BIM library. Bibliothèque BIM. Библиотека BIM.

Exagres se suma al sistema de trabajo en BIM, distribuyendo a los agentes intervinientes de la edificación sus productos cerámicos. Los modelos BIM contienen los datos necesarios para que los prescriptores puedan elegir el material siguiendo los criterios pertinentes para cada uso. Además, el arquitecto podrá generar imágenes de alta calidad, para poder mostrar a sus clientes el ambiente con mayor fidelidad.

Exagres joins the BIM work system, distributing its ceramic products to the agents involved in building. BIM models contain the required data in order to construction specifiers can choose the right material according to the relevant criteria for each use. Furthermore, the architect will be able to generate high quality images to show the environment to his customers with greater accuracy.

Exagres s'associe au système de travail BIM, en distribuant aux agents intervenants de la construction leur produits en céramique. Les modèles BIM contiennent les données nécessaires pour que les prescripteurs puissent choisir le matériel en suivant les critères pertinentes pour chaque usage. En plus, l'architecte pourra générer des images d'haute qualité, pour pouvoir montrer aux clients l'ambiance avec plus de fidélité.

Exagres присоединяется к современной системе информационного моделирования BIM, распределяя среди участвующих лиц достижения в керамической деятельности. Модели BIM содержат в себе все необходимые данные, позволяющие выбирать материал в соответствии с особенностями каждого использования. Кроме того, архитектор сможет генерировать высококачественные изображения и демонстрировать клиентам пространства с большей точностью.

BIM

What we offer.

Tools and facilities for architecture professionals.



Índice tipologías.

Typologies index. Index des typologies. Указатель типологий.

MARBLE

Imperial in&out&in P. 18



Venatto in&out&in P. 38



Nubia in&out&in P. 50



Marbles in&out&in P. 58

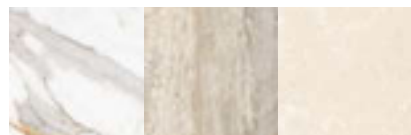

WOOD

Lizana in&out P. 68



Yoho in&out P. 90



URBAN

Cosmos in&out P. 104



Ópera in&out&in P. 120

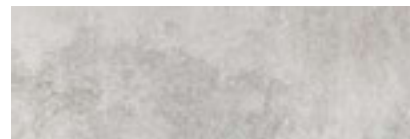

Mediterráneo in&out P. 136



STONE

Bedford in&out P. 142



Ardenas in&out P. 158



Ardenas 20 mm outdoor P. 184



Albaroc in&out P. 196



Litos in&out&in P. 204



Manhattan in&out P. 212



Vega indoor P. 220



EARTH

Provenza in&out P. 224



Portland outdoor P. 242



Alhamar in&out P. 254



METAL

Metálica indoor P. 262



Índice formatos.

Formats index. Index des formats. Указатель форматов.

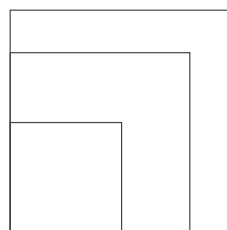

120x120 cm - 47.2"x47.2" *

Imperial	MARBLE	18
Venatto	MARBLE	38
Cosmos	URBAN	104
Ópera	URBAN	120
Bedford	STONE	142
Ardenas	STONE	158
Provenza	URBAN	224

100x100 cm - 39.4"x39.4" *

Albaroc	STONE	196
Litos	STONE	204

60x60 cm - 23.6"x23.6" *

Imperial	MARBLE	18
----------	--------	----



60x120 cm - 23.6"x47.2" *

Imperial	MARBLE	18
Venatto	MARBLE	38
Nubia	MARBLE	50
Marbles	MARBLE	58
Cosmos	URBAN	104
Ópera	URBAN	120
Bedford	STONE	142
Ardenas	STONE	158
Litos	STONE	204
Provenza	URBAN	224

60x120 cm - 23.6"x47.2" *

Ardenas 20 MM	STONE	184
---------------	-------	-----

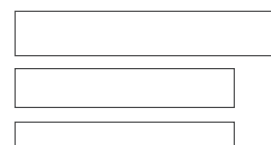

25x150 cm - 9.8"x59.0" *

Lizana	WOOD	68
Yoho	WOOD	90

20x120 cm - 7.9"x47.2" *

Lizana	WOOD	68
--------	------	----

14,5x120 cm - 5.7"x47.2" *

Imperial	MARBLE	18
Venatto	MARBLE	38
Marbles	MARBLE	58
Lizana	WOOD	68
Yoho	WOOD	90
Cosmos	URBAN	104
Ópera	URBAN	120
Bedford	STONE	142
Ardenas	STONE	158
Albaroc	STONE	196
Litos	STONE	204
Provenza	URBAN	224



33x66,5 cm - 13.0"x26.2"

Imperial	MARBLE	18
Venatto	MARBLE	38
Nubia	MARBLE	50
Marbles	MARBLE	58
Cosmos	URBAN	104
Ópera	URBAN	120
Mediterráneo	URBAN	136
Bedford	STONE	142
Ardenas	STONE	158
Albaroc	STONE	196
Litos	STONE	204

16,25x66,5 cm - 6.4"x26.2"

Lizana	WOOD	68
Yoho	WOOD	90



33x33 cm - 13.0"x13.0"

Mediterráneo	URBAN	136
Bedford	STONE	142
Ardenas	STONE	158
Albaroc	STONE	196
Vega	STONE	220
Provenza	URBAN	224
Portland	EARTH	242
Alhamar	EARTH	254
Metálica	METAL	262

16,25x33 cm - 6.4"x13.0"

Ardenas	STONE	158
Provenza	URBAN	224
Alhamar	EARTH	254

16,25x16,25 cm - 6.4"x6.4"

Ardenas	STONE	158
Provenza	URBAN	224
Alhamar	EARTH	254



24,5x24,5 cm - 9.6"x9.6"

Manhattan	STONE	212
-----------	-------	-----

12x24,5 cm - 4.7"x9.6"

Manhattan	STONE	212
-----------	-------	-----

5,75x24,5 cm - 2.3"x9.6"

Manhattan	STONE	212
-----------	-------	-----

Gres extruido · extruded klinker · grès extrudé · экструдированный керамогранит

Gres porcelánico extruido · extruded porcelain stoneware · grès porcelainé extrudé · экструдированный керамогранит

* Gres porcelánico · porcelain stoneware · grès porcelainé · керамогранит

Índice piezas piscinas (según morfología).

Pools pieces index (according to morphology).

Index des pièces de piscine (selon la morphologie).

Указатель деталей плавательных бассейнов (в зависимости от морфологии).

Sistema de coronación skimmer. Skimmer coping system

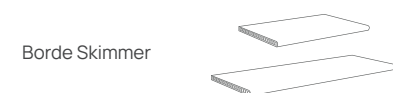

Imperial	MARBLE	18
Venatto	MARBLE	38
Yoho	WOOD	90
Ópera	URBAN	120
Bedford	STONE	142
Ardenas	STONE	158
Provenza	URBAN	224



Lizana	WOOD	68
--------	------	----



Imperial	MARBLE	18
Nubia	MARBLE	50
Marbles**	MARBLE	58
Lizana	WOOD	68
Yoho	WOOD	90
Cosmos	URBAN	104
Ópera	URBAN	120
Bedford	STONE	142
Ardenas	STONE	158
Albaroc	STONE	196
Litos	STONE	204
Provenza	URBAN	224

Sist. de coronación desbordante. Overflow coping system

Borde Desbordante / Rejilla
Áng. Desbordante / Áng. Rejilla
Rejilla conector / Áng. Rejilla Conector

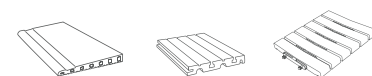

Imperial	MARBLE	18
Venatto	MARBLE	38
Lizana	WOOD	68
Ópera	URBAN	120
Bedford	STONE	142
Litos	STONE	204
Provenza	URBAN	224

Sistema infinity. Infinity system



Imperial	MARBLE	18
Nubia	MARBLE	50
Marbles	MARBLE	58
Lizana	WOOD	68
Yoho	WOOD	90
Cosmos	URBAN	104
Ópera	URBAN	120
Bedford	STONE	142
Ardenas	STONE	158
Albaroc	STONE	196
Litos	STONE	204
Provenza	URBAN	224

Piezas vaso piscina. Pool tank pieces

Media caña / Arista
Uña / Uña Arista
Áng. int. Arista / Áng. ext. Arista

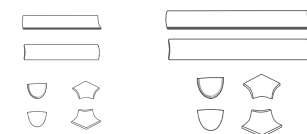

Imperial	MARBLE	18
Venatto	MARBLE	38
Nubia	MARBLE	50
Marbles	MARBLE	58
Ópera	URBAN	120
Bedford	STONE	142
Litos	STONE	204

Índice acabados.

Finishes index. Indice de finitions. финишный индекс.

indoor

☒ C-1 ☒ R9

Imperial	MARBLE	18
Venatto	MARBLE	38
Nubia	MARBLE	50
Marbles	MARBLE	58
Lizana	WOOD	68
Yoho	WOOD	90
Cosmos	URBAN	104
Ópera	URBAN	120
Mediterráneo	URBAN	136
Bedford	STONE	142
Ardenas	STONE	158
Litos	STONE	204
Vega	STONE	220
Provenza	URBAN	224
Alhamar	EARTH	254
Metálica	METAL	262

☒ C-1 ☒ R10

Albaroc	STONE	196
---------	-------	-----

outdoor

☒ C-3 ☒ R11 ☒ C Class

Imperial	MARBLE	18
Venatto	MARBLE	38
Nubia	MARBLE	50
Marbles	MARBLE	58
Yoho	WOOD	90
Cosmos	URBAN	104
Mediterráneo	URBAN	136

☒ C-3 ☒ R12 ☒ C Class

Lizana	WOOD	68
Ópera	URBAN	120
Bedford	STONE	142
Ardenas	STONE	158
Ardenas 20	STONE	184
Albaroc	STONE	196
Litos	STONE	204
Provenza	URBAN	224

☒ C-3 ☒ R12

Portland	EARTH	242
Alhamar	EARTH	254

☒ C-2 ☒ R10

Vega	STONE	220
------	-------	-----

☒ C-2 ☒ R11

Manhattan	STONE	212
-----------	-------	-----

*Para más información de formatos y piezas disponibles, ver cada serie en concreto · For more information on available formats and parts, see each specific series · Pour plus d'informations sur les formats et les pièces disponibles, voir chaque série spécifique · Для получения дополнительной информации о доступных форматах и деталях см. каждую конкретную серию

**La serie Marbles tiene disponibilidad de peldaños rectos en formato 33x120 y 33x60 · The Marbles series is available in straight steps in 33x120 and 33x60 format · La série Marbles est disponible en marches droites au format 33x120 et 33x60 · Серия Marbles выпускается в виде прямых ступеней в формате 33x120 и 33x60.



MARBLE

Imperial
in&out&in



ESPAÑOL



ENGLISH

Imperial serie

in&out&in

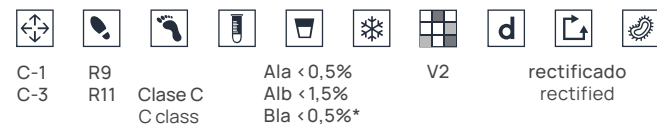

acabados. finishes



Arian

Ceniza

Moca

Siena



120x120 cm*
47.2" x 47.2"

10 mm
C-1 R9
C-3 R11 C Class



60x120 cm*
23.6" x 47.2"

10 mm
C-1 R9
C-3 R11 C Class



14,5x120 cm*
5.7" x 47.2"

9,2 mm
C-1 R9

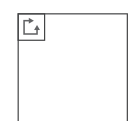

60x60 cm*
23.6" x 23.6"

9,4 mm
C-1 R9



33x66,5 cm
13.0" x 26.2"

10 mm
C-1 R9
C-3 R11 C Class

Alb / Gres Extruido · Extruded Klinker · Grès Extrudé · Экструдированный Керамогранит
Ala / Gres Porcelánico Extruido · Extruded Porcelain Stoneware · Grès Porcelainé Extrudé · Экструдированный Керамогранит
*Bla / Gres Porcelánico · Porcelain Stoneware · Grès Porcelainé · Керамогранит

piezas piscina. pool pieces

	Borde skimmer 45 x 75 x 3 cm 17.7" x 29.5" x 1.2"
	Borde desbordante 28 x 66,5 cm 11.0" x 26.2"
	Ángulo desbordante 31 x 31 cm 12.2" x 12.2"
	Rejilla 24,5 x 24,5 cm 9.6" x 9.6"
	Áng. rejilla izda./dcha. 33 x 33 cm 13.0" x 13.0"
	Media caña 4 4,2 x 33 cm 1.7" x 13.0"
	Arista 3 3,3 x 33 cm 1.3" x 13.0"
	Uña media caña 4 4,2 x 4,2 cm 1.7" x 1.7"
	Uña arista 3 3,3 x 3,3 cm 1.3" x 1.3"
	Ángulo arista 3 3,3 x 4,2 x 5 cm 1.3" x 1.7" x 2.0"
	Áng. media caña 4 4,2 x 3,3 x 5 cm 1.7" x 1.3" x 2.0"

peldaños y rodapiés. steps&skirtings

	Peldaño recto 120 33 x 120 x 3 cm 13.0" x 47.2" x 1.2"
	Peldaño ML 120 33 x 120 x 4 cm 13.0" x 47.2" x 1.6"
	Remate peldaño recto 3 x 33 cm 1.2" x 13.0"
	Remate peldaño ML izda./dcha. 4 x 33 cm 1.6" x 13.0"
	Zanquín ingletado recto 59,6 x 59,6 cm 23.5" x 23.5"
	Zanquín ingletado ML izda./dcha. 59,6 x 59,6 cm 23.5" x 23.5"
	Rodapié 9 x 60 cm 3.5" x 23.6"

Imperial indoor



arian]

- 1 Base · 60x120 cm - C-1 / R9
- 2 Peldaño ML120 · 33x120x4 cm - C-1 / R9

- 3 Tabica · 14,5x120 cm - C-1 / R9
- 4 Zanquin · 59,6x59,6 cm



1

1

4

2

3

Imperial in&out



moca]

- 1 Base · 60x60 cm - C-1 / R9
- 2 Peldaño ML 120 · 33x120x4 cm - C-1 / R9
- 3 Tabica · 14,5x120 cm - C-1 / R9
- 4 Base · 60x120 cm - C-3 / R11+C
- 5 Borde skimmer · 45x75x3 cm - C-3 / R11+C

arian]

- 1 Base · 120x120 cm - C-1 / R9
- 2 Base · 60x120 cm - C-1 / R9
- 3 Peldaño recto 120 · 33x120x3 cm - C-1 / R9
- 4 Tabica · 14,5x120 cm - C-1 / R9
- 5 Base orobico taupe · 60x120 cm - C-1 / R9
- 6 Base · 120x120 cm - C-3 / R11+C



Imperial in&out+ overflow pool coping

ceniza]

- 1 Base · 60x60 cm - C-1 / R9
- 2 Base · 60x120 cm - C-3 / R11+C

- 3 Base ópera ivory · 60x120 cm - C-1 / R9
- 4 Borde desbordante 28x66,5 cm - C-3 / R11+C

- 5 Rejilla · 24,5x24,5 cm - C-3 / R11+C



Imperial in&out+ overflow pool coping



- moca]
- 1 Base - 60x120 cm - C-1 / R9
 - 2 Base - 60x120 cm - C-3 / R11+C
 - 3 Peldaño recto 120 - 33x120x3 cm - C-3 / R11+C
 - 4 Borde desbordante 28x66,5 cm - C-3 / R11+C
 - 5 Rejilla - 24,5x24,5 cm - C-3 / R11+C
 - 6 Base - 33x66,5 cm - C-1 / R9
 - 7 Base - 33x66,5 cm - C-3 / R11+C



Imperial in&out+ overflow pool coping

- siena]
- 1 Base · 60x120 cm - C-1 / R9
 - 2 Base · 60x120 cm - C-3 / R11+C
 - 3 Borde desbordante 28x66,5 cm - C-3 / R11+C
 - 4 Áng. desbordante 31x31 cm - C-3 / R11+C
 - 5 Rejilla · 24,5x24,5 cm - C-3 / R11+C
 - 6 Áng. rejilla · 33x33 cm - C-3 / R11+C
 - 7 Peldaño recto 120 · 33x120x3 cm - C-3 / R11+C
 - 8 Tabica · 14,5x120 cm - C-1 / R9



Imperial in&out+ overflow pool coping



- moca]
- 1 Base · 60x120 cm - C-3 / R11+C
 - 2 Peldaño recto 120 · 33x120x3 cm - C-3 / R11+C
 - 3 Borde desbordante · 28x66,5 cm - C-3 / R11+C

- 4 Tabica · 14,5x120 cm - C-1 / R9
- 5 Rejilla · 24,5x24,5 cm - C-3 / R11+C
- 6 Remate peldaño recto · 3x33 cm - C-1 / R9

- 7 Media caña 4 · 4,2x33 cm
- 8 Uña media caña 4 · 4,2x4,2 cm

- ceniza]
- 1 Base · 60x120 cm - C-3 / R11+C
 - 2 Base · 60x60 cm - C-1 / R9

- 3 Borde desbordante 28x66,5 cm - C-3 / R11+C
- 4 Áng. desbordante 31x31 cm - C-3 / R11+C

- 5 Rejilla · 24,5x24,5 cm - C-3 / R11+C
- 6 Áng. rejilla · 33x33 cm - C-3 / R11+C

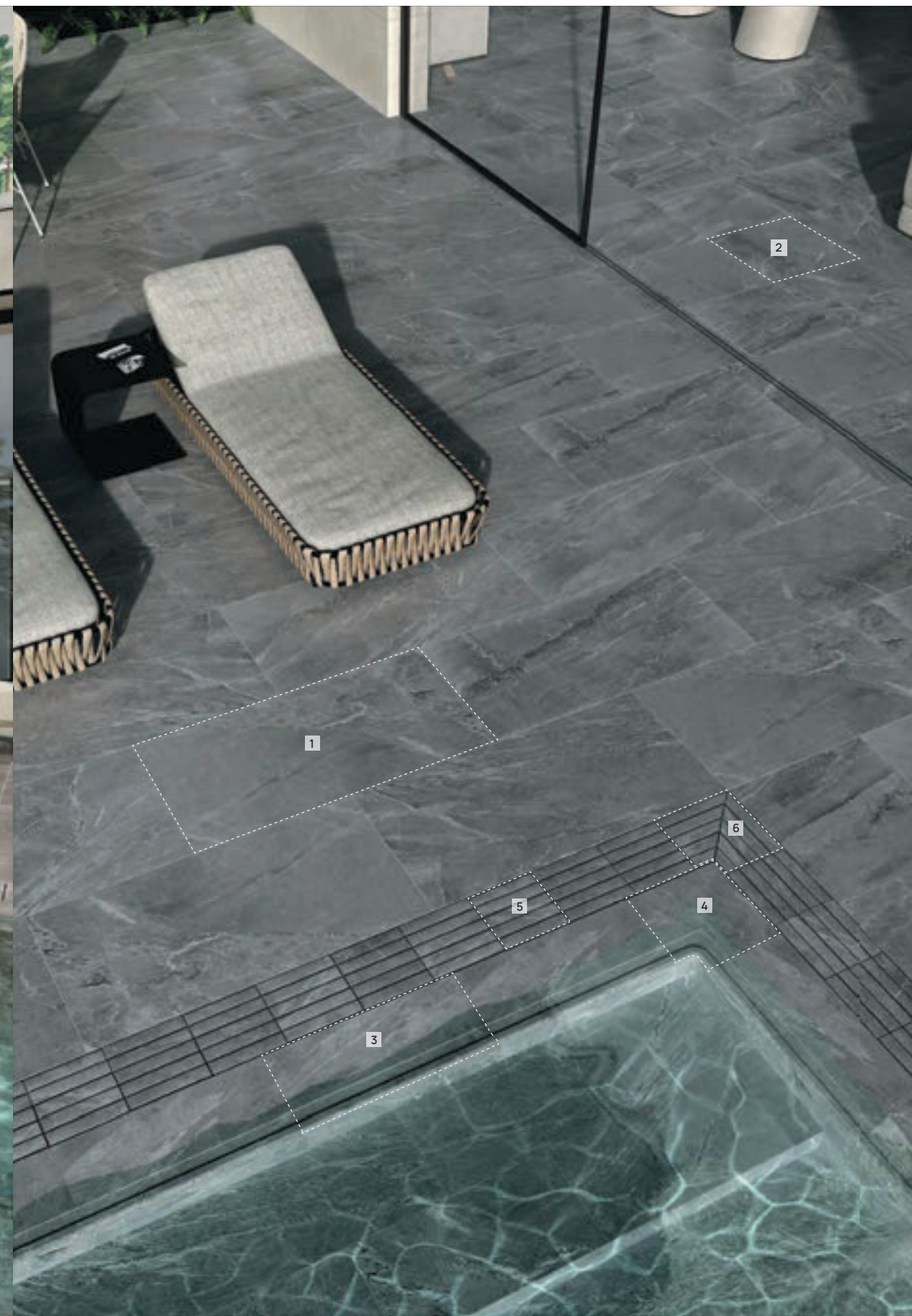

Borde desbordante
28 x 66,5 cm - 11.0" x 26.2"

C-3 R11 C



Ángulo desbordante
31 x 31 cm - 12.2" x 12.2"

C-3 R11 C



Rejilla
24,5 x 24,5 cm - 9.6" x 9.6"

C-3 R11 C



Áng. rejilla izda./dcha.
33 x 33 cm - 13.0" x 13.0"

C-3 R11 C



Media caña 4
4,2 x 33 cm - 1.7" x 13.0"



Uña media caña 4
4,2 x 4,2 cm - 1.7" x 1.7"



Imperial indoor+ skimmer pool coping

siena]

- 1 Base · 120x120 cm - C-3 / R11+C
- 2 Base · 60x120 cm - C-1 / R9

- 3 Borde skimmer · 45x75x3 cm - C-3 / R11
- 4 Peldaño recto 120 · 33x120x3 cm - C-3 / R11

- 5 Tabica · 14,5x120 cm - C-1 / R9 - C-1 / R9
- 6 Base yoho teca · 25x150 cm - C-3 / R11+C



Imperial outdoor+ skimmer pool coping



- arian]
- 1 Base · 60x120 cm - C-3 / R11+C
 - 2 Borde skimmer · 45x75x3 cm - C-3 / R11+C
 - 3 Tabica · 14,5x120 cm - C-1 / R9
 - 4 Peldaño recto 120 · 33x120x3 cm - C-3 / R11+C
 - 5 Base · 33x66,5 cm - C-1 / R9

- siena]
- 1 Base · 120x120 cm - C-3 / R11+C
 - 2 Borde skimmer · 45x75x3 cm - C-3 / R11+C
 - 3 Arista 3 · 3,3x33 cm
 - 4 Media caña 4 · 4,2x33 cm
 - 5 Áng. Arista 3 · 3,3x4,2x5 cm
 - 6 Base · 33x66,5 cm - C-1 / R9
 - 7 Base · 33x66,5 cm - C-3 / R11+C



Borde skimmer
45 x 75 x 3 cm
17.7" x 29.5" x 1.2"

C-3 R11 C



Peldaño recto 120
33 x 120 x 3 cm
13.0" x 47.2" x 1.2"

C-3 R11 C



Arista 3
3,3 x 33 cm - 1.3" x 13.0"



Media caña 4
4,2 x 33 cm - 1.7" x 13.0"



Ángulo arista 3
3,3 x 4,2 x 5 cm - 1.3" x 1.7" x 2.0"





MARBLE

Venatto
in&out&in



ESPAÑOL



ENGLISH

Venatto serie in&out&in

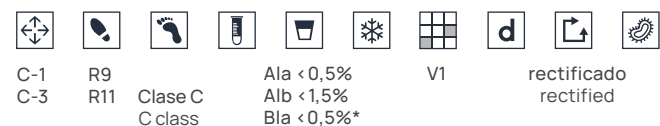

acabados. finishes



Perla

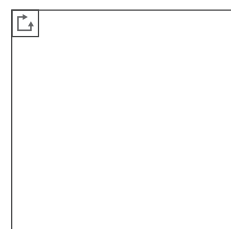

120x120 cm*
47.2"x 47.2"

10 mm
C-1 R9
C-3 R11 C Class



60x120 cm*
23.6"x 47.2"

10 mm
C-1 R9
C-3 R11 C Class



14,5x120 cm*
5.7"x 47.2"

10 mm
C-1 R9



33x66,5 cm
13.0"x 26.2"

10 mm
C-1 R9
C-3 R11 C Class

Alb / Gres Extruido · Extruded Klinker · Grès Extrudé · Экструдированный Керамогранит
Ala / Gres Porcelánico Extruido · Extruded Porcelain Stoneware · Grès Porcelainé Extrudé · Экструдированный Керамогранит
*Bla / Gres Porcelánico · Porcelain Stoneware · Grès Porcelainé · Керамогранит

piezas piscina. pool pieces

	<p>Borde skimmer 45 x 75 x 3 cm 17.7" x 29.5" x 1.2"</p> <p>rectificado. rectified C-3 R11 C</p> <p>3D design Continuidad gráfica en parte trasera. Digitally printed backside.</p>
	<p>Borde desbordante 28 x 66,5 cm 11.0" x 26.2"</p> <p>rectificado. rectified C-3 R11 C</p>
	<p>Ángulo desbordante 31 x 31 cm 12.2" x 12.2"</p> <p>rectificado. rectified C-3 R11 C</p>
	<p>Rejilla 24,5 x 24,5 cm 9.6" x 9.6"</p> <p>rectificado. rectified C-3 R11 C</p>
	<p>Áng. rejilla izda./dcha. 33 x 33 cm 13.0" x 13.0"</p> <p>rectificado. rectified C-3 R11 C</p> <p>*set de 2 piezas (izda./dcha.) *two pieces set (left/right)</p>
	<p>Media caña 4 4,2 x 33 cm 1.7" x 13.0"</p>
	<p>Arista 3 3,3 x 33 cm 1.3" x 13.0"</p>
	<p>Uña media caña 4 4,2 x 4,2 cm 1.7" x 1.7"</p>
	<p>Uña arista 3 3,3 x 3,3 cm 1.3" x 1.3"</p>
	<p>Ángulo arista 3 3,3 x 4,2 x 5 cm 1.3" x 1.7" x 2.0"</p>
	<p>Áng. media caña 4 4,2 x 3,3 x 5 cm 1.7" x 1.3" x 2.0"</p>

peldaños y rodapiés. steps&skirtings

	<p>Peldaño ML120 33 x 120 x 4 cm 13.0" x 47.2" x 1.6"</p> <p>13 mm</p> <p>rectificado. rectified C-1 R9 C-3 R11 C</p>
	<p>Remate peldaño ML izda./dcha. 4 x 33 cm 1.6" x 13.0"</p> <p>7,5 mm</p>
	<p>Zanquín ingletado ML izda./dcha. 59,6 x 59,6 cm 23.5" x 23.5"</p> <p>11 mm</p>
	<p>Rodapié 9 x 60 cm 3.5" x 23.6"</p> <p>11 mm</p>

Venatto in&out



perla]

- 1 Base - 120x120 cm - C-1 / R9
- 2 Base - 120x120 cm - C-3 / R11+C

- 3 Peldaño ML120 - 33x120x4 cm - C-1 / R9
- 4 Tabica - 14,5x120 cm - C-1 / R9

- 5 Base ópera silver - 60x120 cm - C-1 / R9



Venatto indoor

- perla]
- 1 Base · 60x120 cm - C-1 / R9
 - 2 Peldaño ML 120 · 33x120x4 cm - C-1 / R9

- 3 Tabica · 14,5x120 cm - C-1 / R9

Venatto outdoor

- 4 Peldaño ML 120 · 33x120x4 cm - C-3 / R11+C
- 5 Base · 120x120 cm - C-3 / R11+C



Peldaño ML 120
33 x 120 x 4 cm - 13.0" x 47.2" x 1.6"

C-1 R9



Peldaño ML 120
33 x 120 x 4 cm - 13.0" x 47.2" x 1.6"

C-3 R11 C



Tabica
14,5 x 120 - 5.7" x 47.2"

C-1 R9



Venatto in&out+skimmer pool coping



perla]

- 1 Base · 120x120 cm - C-1 / R9
- 2 Base · 120x120 cm - C-3 / R11+C

- 3 Peldaño ML120 · 33x120x4 cm - C-1 / R9
- 4 Borde skimmer · 45x75x3 cm - C-3 / R11+C

- 5 Base orobico taupe · 60x120 cm - C-1 / R9



Venatto overflow pool coping

perla]

- 1 Base · 120x120 cm - C-3 / R11+C
- 2 Borde desbordante · 28x66,5 cm - C-3 / R11+C
- 3 Rejilla · 24,5x24,5 cm - C-3 / R11+C
- 4 Base · 33x66,5 cm - C-3 / R11+C
- 5 Peldaño ML · 33x120x4 cm - C-3 / R11+C
- 6 Peldaño recto yoho teca · 33x120x3 cm - C-3 / R11+C

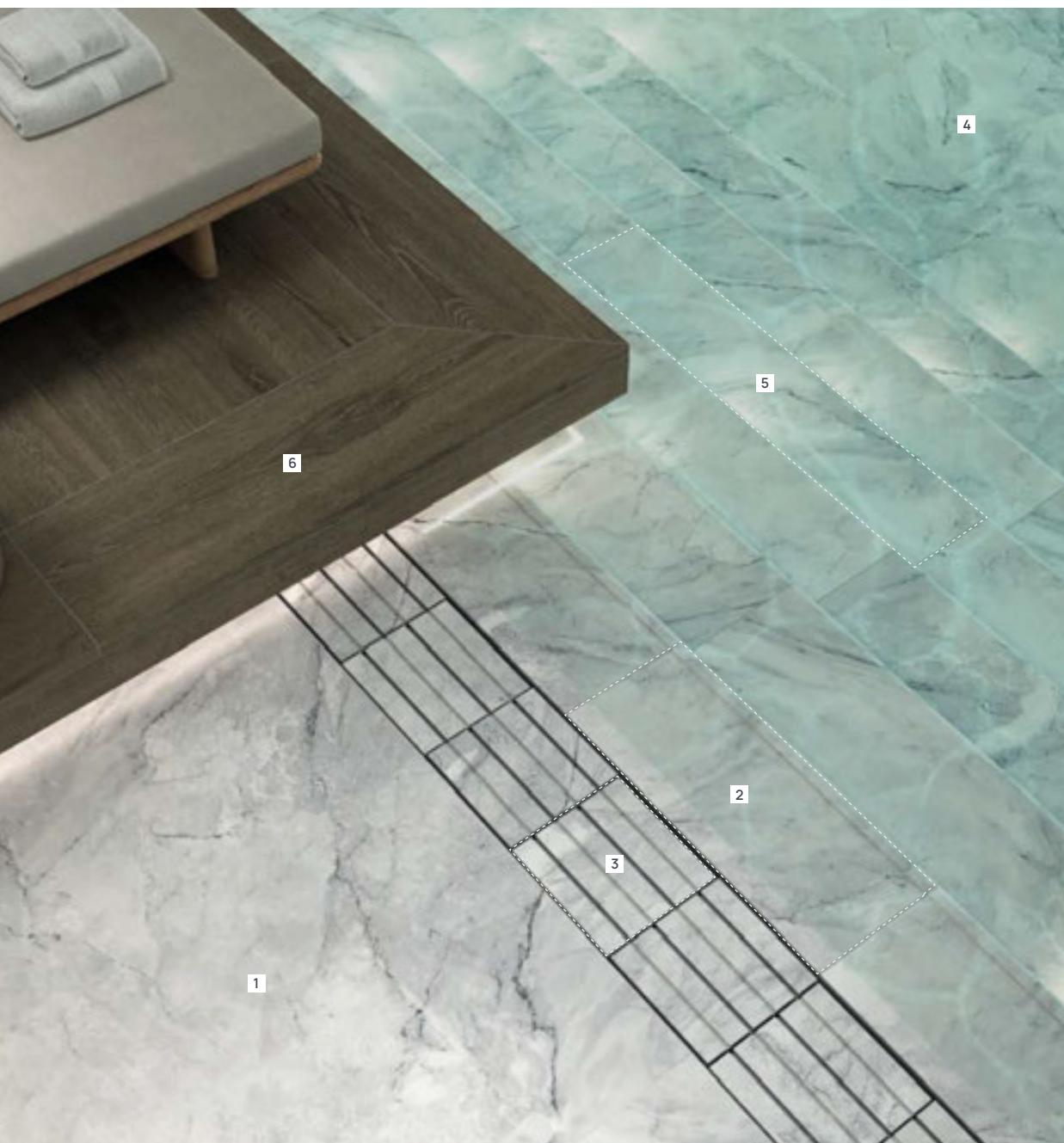

Borde desbordante
28 x 66,5 cm - 11.0" x 26.2"

C-3 R11 C



Rejilla
24,5 x 24,5 cm - 9.6" x 9.6"

C-3 R11 C



Peldaño ML 120
33 x 120 x 4 cm - 13.0" x 47.2" x 1.6"

C-3 R11 C



Peldaño recto 120 Yoho teca
33 x 120 x 3 cm - 13.0" x 47.2" x 1.2"

C-3 R11 C



Venatto skimmer pool coping

- 7 Borde skimmer · 45x75x3 cm - C-3 / R11+C
- 8 Media caña 4 · 4,2x33 cm
- 9 Uña media caña 4 · 4,2x4,2 cm
- 10 Base · 33x66,5 cm - C-1 / R9
- 11 Base orobico taupe · 60x120 cm - C-1 / R9
- 12 Peldaño ML · 33x120x4 cm - C-1 / R9



Borde skimmer
45 x 75 x 3 cm - 17.7" x 29.5" x 1.2"

C-3 R11 C



Media caña 4
4,2 x 33 cm
1.7" x 13.0"



Uña media caña 4
4,2 x 4,2 cm - 1.7" x 1.7"



Peldaño ML 120
33 x 120 x 4 cm - 13.0" x 47.2" x 1.6"

C-3 R11 C





MARBLE

Nubia
in&out&in



ESPAÑOL



ENGLISH

Nubia serie

in&out&in

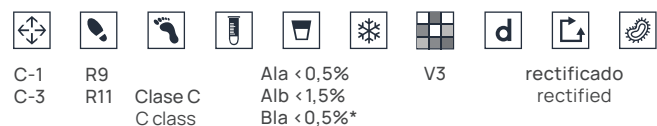

acabados. finishes

piezas piscinas. pool pieces / peldaños. steps



	<p>Peldaño recto 120 33 x 120 x 3 cm 13.0" x 47.2" x 1.2"</p> <p>12 mm</p> <p>rectificado. rectified</p> <p>C-1 R9 C-3 R11 C</p>
	<p>Media caña 4 4,2 x 33 cm 1.7" x 13.0"</p>
	<p>Arista 3 3,3 x 33 cm 1.3" x 13.0"</p>
	<p>Uña media caña 4 4,2 x 4,2 cm 1.7" x 1.7"</p>
	<p>Uña arista 3 3,3 x 3,3 cm 1.3" x 1.3"</p>

Nubia



60x120 cm*
23.6" x 47.2"

10 mm

C-1 R9

C-3 R11 C Class



33x66,5 cm
13.0" x 26.2"

10 mm

C-1 R9

C-3 R11 C Class

Alb / Gres Extruido · Extruded Klinker · Grès Extrudé · Экструдированный Керамогранит
Ala / Gres Porcelánico Extruido · Extruded Porcelain Stoneware · Grès Porcelainé Extrudé · Экструдированный Керамогранит
*Bla / Gres Porcelánico · Porcelain Stoneware · Grès Porcelainé · Керамогранит



- | | | |
|---|--|--|
| 1 Base · 60x120 cm / 33x66,5 cm - C-1 / R9 | 4 Media caña 4 · 4,2x33 cm | 7 Base ópera ivory · 60x120 cm - C-3 / R11+C |
| 2 Base · 33x66,5 cm - C-3 / R11+C | 5 Base yoho maple · 25x150 cm - C-3 / R11+C | 8 Borde desbordante · 28x66,5 cm - C-3 / R11+C |
| 3 Peldaño recto 120 · 33x120x3 cm - C-3 / R11+C | 6 Peldaño recto 120 yoho maple · 33x120x3 cm - C-3 / R11+C | 9 Rejilla · 24,5x24,5 cm - C-3 / R11+C |

Nubia in&out



nubia]

- 1 Base · 60x120 cm - C-1 / R9
- 2 Base · 33x66,5 cm - C-3 / R11+C

- 3 Peldaño recto 120 · 33x120x3 cm - C-1 / R9
- 4 Tabica · 14,5x120 cm - C-1 / R9



4

3

1

2

Nubia in&out

nubia] 1 Base · 60x120 cm - C-1 / R9
2 Base · 60x120 cm - C-3 / R11+C

3 Base yoho maple · 25x150 cm - C-1 / R9





MARBLE

Marbles
in&out&in



ESPAÑOL



ENGLISH



FRANÇAIS

Marbles serie in&out&in

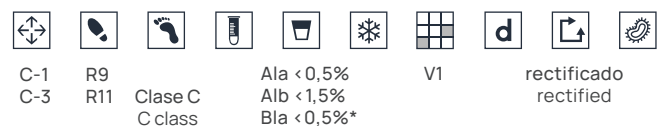

acabados. finishes



Calacatta

Travertino

Crema marfil



60x120 cm*
23.6" x 47.2"

10 mm
C-1 R9



14,5x120 cm*
5.7" x 47.2"

10 mm
C-1 R9

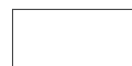

33x66,5 cm
13.0" x 26.2"

10 mm
C-1 R9
C-3 R11 C Class

piezas piscina. pool pieces

	<p>Peldaño recto 60 33 x 60 x 3 cm 13.0" x 23.6" x 1.2" 12 mm rectificado. rectified C-3 R11 C</p>
	<p>Media caña 4 4,2 x 33 cm 1.7" x 13.0"</p>
	<p>Arista 3 3,3 x 33 cm 1.3" x 13.0"</p>
	<p>Uña media caña 4 4,2 x 4,2 cm 1.7" x 1.7"</p>
	<p>Uña arista 3 3,3 x 3,3 cm 1.3" x 1.3"</p>

peldaños y rodapiés. steps&skirtings

	<p>Peldaño recto 120 33 x 120 x 3 cm 13.0" x 47.2" x 1.2" 12 mm rectificado. rectified C-3 R11 C</p>
	<p>Peldaño Fiorentino 120 33 x 120 x 3 cm 13.0" x 47.2" x 1.2" 12 mm rectificado. rectified C-1 R9</p>
	<p>Remate peldaño recto 3 x 33 cm 1.2" x 13.0" 7,5 mm</p>
	<p>Remate peldaño fiorentino izda./dcha. 3 x 33 cm 1.2" x 13.0" 7,5 mm</p>
	<p>Zanquín recto 18 x 40 cm 7.1" x 15.7" 15 mm</p>
	<p>Zanquín fiorentino izda./dcha. 18 x 40 cm 7.1" x 15.7" 15 mm</p>
	<p>Rodapié 9 x 40 cm 3.5" x 15.7" 15 mm</p>

Alb / Gres Extruido · Extruded Klinker · Grès Extrudé · Экструдированный Керамогранит
Ala / Gres Porcelánico Extruido · Extruded Porcelain Stoneware · Grès Porcelainé Extrudé · Экструдированный Керамогранит
*Bla / Gres Porcelánico · Porcelain Stoneware · Grès Porcelainé · Керамогранит

Marbles indoor



travertino] 1 Base - 60x120 cm - C-1 / R9



crema marfil] 1 Base - 60x120 cm - C-1 / R9 2 Peldaño recto 120 · 33x120x3 cm - C-3 / R11+C 3 Tabica · 14,5x120 cm - C-1 / R9



Marbles outdoor+skimmer pool coping



travertino]

1 Base · 33x66,5 cm - C-3 / R11+C

2 Peldaño recto 120 · 33x120x3 cm - C-3 / R11+C

3 Peldaño recto 60 · 33x60x3 cm - C-3 / R11+C

4 Tabica · 14,5x120 cm

5 Base · 33x66,5 - C-1 / R9



Marbles outdoor+skimmer pool coping



calacatta]

- 1 Base · 33x66,5 cm - C-3 / R11+C
- 2 Peldaño recto 60 · 33x60x3 cm - C-3 / R11+C

- 3 Media caña 4 · 4,2x33 cm
- 4 Base · 33x66,5 cm - C-1 / R9
- 5 Uña media caña 4 · 4,2x4,2 cm

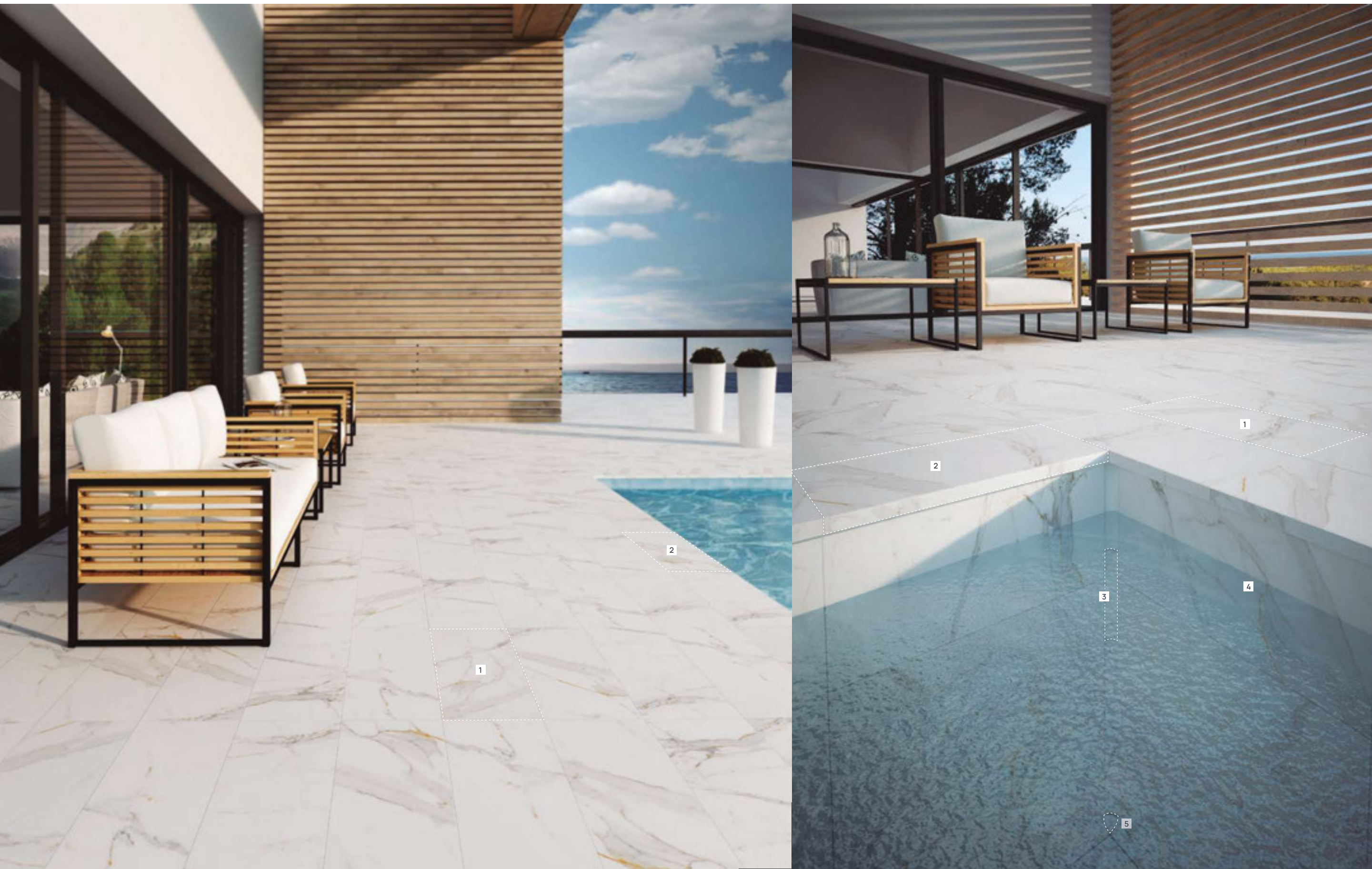

Peldaño recto 60
33 x 60 x 3 cm - 13.0" x 23.7" x 1.2"

C-3 R11 C

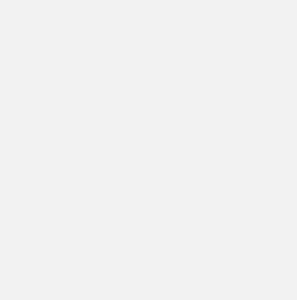

Media caña 4
4,2 x 33 cm - 1.7" x 13.0"

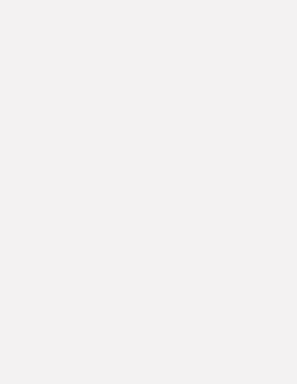

Uña media caña 4
4,2 x 4,2 cm - 1.7" x 1.7"

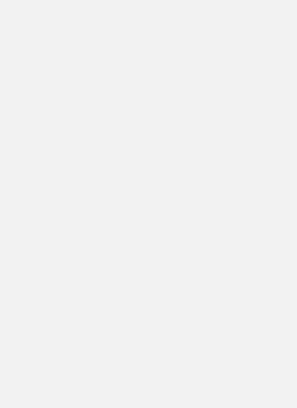



WOOD

Lizana
in&out



ESPAÑOL



ENGLISH



FRANÇAIS

Lizana serie in&out

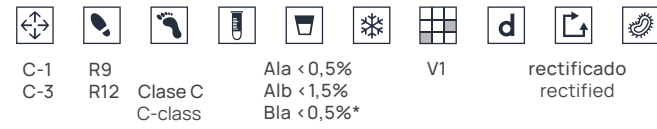

acabados. finishes



Haya Cerezo Olivo Nogal

piezas piscina. pool pieces

Borde desbordante
28 x 66,5 cm
11.0" x 26.2"
rectificado. rectified
C-3 R12 C

Ángulo desbordante
31 x 31 cm
12.2" x 12.2"
rectificado. rectified
C-3 R12 C

Rejilla
24,5 x 66,5 cm
9.6" x 26.2"
rectificado. rectified
C-3 R12 C

Áng. rejilla izda./dcha.
33 x 33 cm
13.0" x 13.0"
rectificado. rectified
C-3 R12 C

*set de 2 piezas (izda./dcha.)
*two pieces set (left/right)

peldaños y rodapiés. steps&skirtings

Peldaño recto 120
33 x 120 x 3 cm
13.0" x 47.2" x 1.2"
12 mm
rectificado. rectified
C-1 R9
C-3 R12 C

Peldaño ML 150
33 x 150 x 4 cm
13.0" x 59.1" x 1.6"
13 mm
rectificado. rectified
C-1 R9
C-3 R12 C

Remate peldaño recto
3 x 33 cm
1.2" x 13.0"
7,5 mm

Remate peldaño ML izda./dcha.
4 x 33 cm
1.6" x 13.0"
7,5 mm

Zanquín ingletado recto
59,6 x 59,6 cm
23.5" x 23.5"
11 mm

Zanquín ingletado ML izda./dcha.
59,6 x 59,6 cm
23.5" x 23.5"
11 mm

Rodapié
9 x 60 cm
3.5" x 23.6"
11 mm



25x150 cm*
9.8" x 59.0"

9 mm
C-1 R9
C-3 R12 C Class

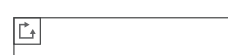

20x120 cm*
7.9" x 47.2"

9 mm
C-1 R9
C-3 R12 C Class



14,5x120 cm*
5.7" x 47.2"

10,1 mm
C-1 R9

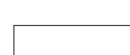

16,25x66,5 cm
6.4" x 26.2"

10 mm
C-3 R12 C Class

Lizana indoor

haya]

- 1 Base · 20x120 cm - C-1 / R9
- 2 Peldaño ML150 · 33x150x4 cm - C-1 / R9
- 3 Tabica · 14,5x120 cm - C-1 / R9
- 4 Base cosmos steel 120x120 cm - C-1 / R9



cerezo]

- 1 Base · 25x150 cm - C-1 / R9
- 2 Base · 20x120 cm - C-1 / R9
- 3 Peldaño ML150 · 33x150x4 cm - C-1 / R9
- 4 Tabica · 14,5x120 cm - C-1 / R9



Lizana indoor

nogal]

- 1 Base · 25x150 cm - C-1 / R9
- 2 Peldaño ML 150 · 33x150x4 cm - C-1 / R9
- 3 Rodapié · 9x60 cm
- 4 Zanquín ingletado ML · 59,6x59,6 cm
- 5 Tabica · 14,5x120 cm - C-1 / R9

nogal]

- 1 Base · 25x150 cm - C-1 / R9
- 2 Peldaño recto 120 · 33x120x3 cm - C-1 / R9
- 3 Tabica · 14,5x120 cm - C-1 / R9



Lizana in&out

cerezo]

1 Base · 25x150 cm - C-1 / R9

2 Peldaño recto 120 · 33x120x3 cm - C-1 / R9

3 Tabica · 14,5x120 cm - C-1 / R9

4 Remate peldaño recto 3x33 cm

5 Base · 16,25x66,5 cm - C-3 / R12+C



Lizana in&out



olivo] **1** Base · 25x150 cm - C-1 / R9
2 Peldaño ML 150 · 33x150x4 cm - C-1 / R9

3 Base · 25x150 cm - C-3 / R12+C



Lizana outdoor



olivo]

- 1 Base · 20x120 cm - C-3 / R12+C
- 2 Peldaño recto 120 · 33x120x3 cm - C-3 / R12+C
- 3 Tabica · 14,5x120 cm - C-1 / R9
- 4 Base cosmos corten · 60x 120 cm - C-1 / R9
- 5 Base cosmos corten · 120x 120 cm - C-1 / R9

haya]

- 1 Base · 20x120 cm - C-1 / R9
- 2 Base · 25x150 cm - C-3 / R12+C
- 3 Peldaño ML150 · 33x150x4 cm - C-3 / R12+C
- 4 Tabica · 14,5x120 cm - C-1 / R9



Lizana in&out+overflow pool coping

haya]

1 Base · 16,25x66,5 cm - C-3 / R12+C
2 Base · 25x120 cm - C-1 / R9

3 Borde desbordante · 28x66,5 cm - C-3 / R12+C
4 Rejilla · 24,5x66,5 cm - C-3 / R12+C

5 Ángulo desbordante · 31x31 cm - C-3 / R12+C
6 Ángulo rejilla · 33x33 cm - C-3 / R12+C



Lizana in&out+overflow pool coping

- haya]
- 1 Base · 16,25x66,5 cm - C-3 / R12+C
 - 2 Base · 25x120 cm - C-1 / R9
 - 3 Borde desbordante · 28x66,5 cm - C-3 / R12+C
 - 4 Rejilla · 24,5x66,5 cm - C-3 / R12+C
 - 5 Ángulo desbordante · 31x31 cm - C-3 / R12+C
 - 6 Ángulo rejilla · 33x33 cm - C-3 / R12+C



Lizana outdoor+overflow pool coping

- olivo]
- 1 Base · 16,25x66,5 cm - C-3 / R12+C
 - 2 Borde desbordante · 28x66,5 cm - C-3 / R12+C
 - 3 Rejilla · 24,5x66,5 cm - C-3 / R12+C
 - 4 Base cosmos venus · 60 x120 cm - C-1 / R9



Lizana in&out+overflow pool coping



olivo]

1 Base · 16,25x66,5 cm - C-3 / R12+C

2 Borde desbordante · 28x66,5 cm - C-3 / R12+C

3 Ángulo desbordante · 31x31 cm - C-3 / R12+C

4 Rejilla · 24,5 x66,5 cm - C-3 / R12+C

5 Ángulo rejilla · 33x33 cm - C-3 / R12+C

6 Peldaño recto 120 ópera ivory · 33x120x3 cm - C-3 / R12+C



Borde desbordante
28 x 66,5 cm - 11.0" x 26.2"

C-3 R12 C

2

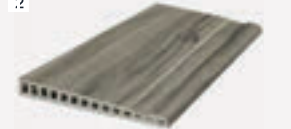

Ángulo desbordante
31 x 31 cm - 12.2" x 12.2"

C-3 R12 C

3



Rejilla
24,5 x 66,5 cm - 9.6" x 26.2"

C-3 R12 C

4



Áng. rejilla izda./dcha.
33 x 33 cm - 13.0" x 13.0"

C-3 R12 C

5



Peldaño recto 120 ópera ivory
33 x 120 x 3 cm - 13.0" x 47.2" x 1.2"

C-3 R12 C

6



Lizana outdoor+skimmer pool coping



nogal] **1** Base · 20x120cm - C-3 / R12+C
2 Peldaño ML 150 · 33x150x4 cm - C-3 / R12+C

3 Peldaño recto 120 · 33x120x3 cm - C-3 / R12+C
4 Tabica · 14,5x120 cm - C-1 / R9

5 Peldaño recto 120 ardenas marfil · 33x120x3 cm - C-3 / R12+C
6 Tabica ardenas marfil · 14,5x120 cm - C-1 / R9

7 Base ardenas marfil · 60x120 cm - C-3 / R12+C
8 Base ardenas marfil · 60x120 cm - C-1 / R9

9 Base imperial siena · 33x66,5 cm - C-1 / R9



Peldaño ML 150
 33 x 150 x 4 cm - 13.0" x 59.1" x 1.6"

⊕ C-3 ↙ R12 ↘ C



Peldaño recto 120
 33 x 120 x 3 cm - 13.0" x 47.2" x 1.2"

⊕ C-3 ↙ R12 ↘ C



Peldaño recto 120 ardenas marfil
 33 x 120 x 3 cm - 13.0" x 47.2" x 1.2"

⊕ C-3 ↙ R12 ↘ C





WOOD

Yoho
in&out



ESPAÑOL / ENGLISH

Yoho serie in&out

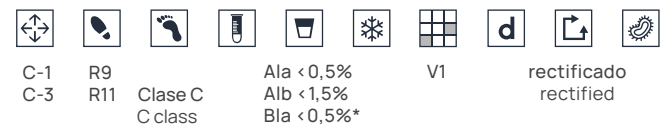

acabados. finishes



Natural

Maple

Oak

Teca



25x150 cm*
9.8" x 59.0"

± 9 mm

C-1 R9

C-3 R11 C Class



14,5x120 cm*
5.7" x 47.2"

± 10,1 mm

C-1 R9

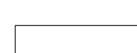

16,25x66,5 cm
6.4" x 26.2"

± 10 mm

C-3 R11 C Class

Alb / Gres Extruido · Extruded Klinker · Grès Extrudé · Экструдированный Керамогранит
Ala / Gres Porcelánico Extruido · Extruded Porcelain Stoneware · Grès Porcelainé Extrudé · Экструдированный Керамогранит
*Bla / Gres Porcelánico · Porcelain Stoneware · Grès Porcelainé · Керамогранит

piezas piscina. pool pieces



peldaños y rodapiés. steps&skirtings

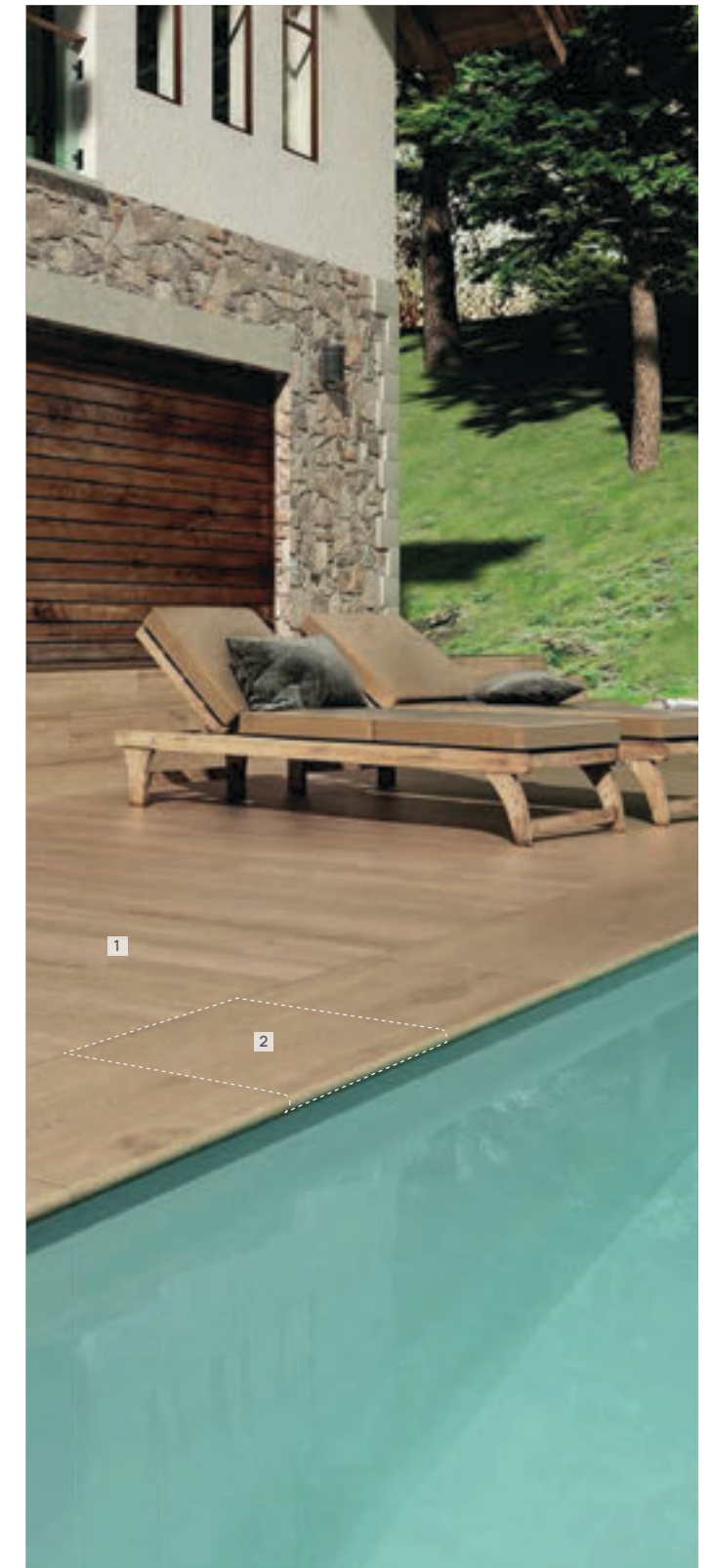
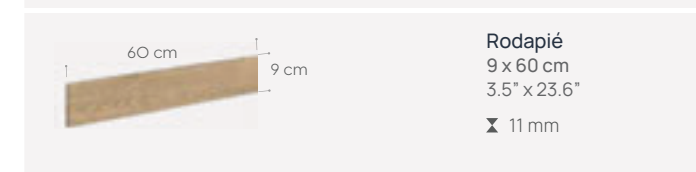
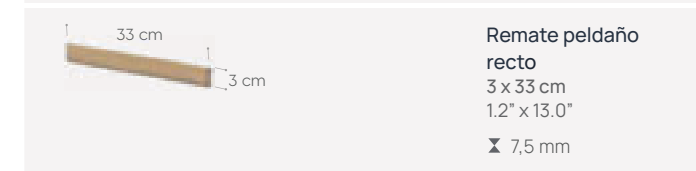

1 Base oak · 25x150 cm - C-3 / R11+C

2 Borde skimmer oak · 45x75x3 cm - C-3 / R11+C

Yoho in&out

maple]

- 1 Base · 24,5x150 cm - C-1 / R9
- 2 Base · 16,25x66,5 cm - C-3 / R11+C

- 3 Peldaño recto 120 · 33x120x3 cm - C-1 / R9
- 4 Tabica · 14,5x120 cm - C-1 / R9



Yoho in&out

natural]

- 1 Base · 25x150 cm - C-3 / R11+C
- 2 Peldaño recto 120 · 33x120x3 cm - C-1 / R9
- 3 Tabica · 14,5x120 cm - C-1 / R9



Yoho in&out+skimmer pool coping

natural]

- 1 Base · 25x150 cm - C-1 / R9
- 2 Base · 16,25x66,5 cm - C-3 / R11+C
- 3 Borde skimmer · 45x75x3 cm - C-3 / R11+C



Yoho in&out+skimmer pool coping

maple]

- 1 Base · 25x150 cm - C-1 / R9
- 2 Base · 25x150 cm - C-3 / R11+C

- 3 Peldaño recto 120 · 33x120x4 cm - C-3 / R11+C
- 4 Tabica · 14,5x120 cm - C-1 / R9

- 5 Borde skimmer · 45x75x3 cm - C-3 / R11+C
- 6 Base nubia · 33x66,5 cm - C-3 / R11+C



Yoho outdoor+skimmer pool coping



natural]

- 1 Base · 25x150 cm - C-3 / R11+C
- 2 Borde skimmer · 45x75x3 cm - C-3 / R11+C

oak]

- 1 Base · 25x150 cm - C-3 / R11+C
- 2 Borde skimmer · 45x75x3 cm - C-3 / R11+C
- 3 Peldaño recto 120 · 33x120x3 cm - C-3 / R11+C
- 4 Tabica · 14,5x120 cm - C-1 / R9



Borde skimmer
45 x 75 x 3 cm - 17.7" x 29.5" x 1.2"

C-3 R11 C

2



Peldaño recto 120
33 x 120 x 4 cm - 13.0" x 47.2" x 1.6"

C-3 R11 C

3



Tabica
14,5 x 120 cm - 5.7" x 47.2"

4



Yoho outdoor



teca] **1** Base · 25x150 cm - C-3 / R11+C
2 Base · 16,25x66,5 cm - C-3 / R11+C

3 Base markina bianco · 60x120 cm - C-1 / R9



1

2

3

4



URBAN

Cosmos
in&out



ESPAÑOL



ENGLISH



FRANÇAIS

Cosmos serie

in&out

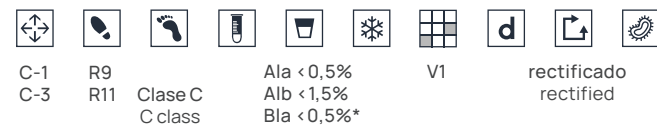

acabados. finishes



Steel Copper Corten Venus

piezas piscina. pool pieces / peldaños y rodapiés. steps&skirtings



Alb / Gres Extruido · Extruded Klinker · Grès Extrudé · Экструдированный Керамогранит
 Ala / Gres Porcelánico Extruido · Extruded Porcelain Stoneware · Grès Porcelainé Extrudé · Экструдированный Керамогранит
 *Bla / Gres Porcelánico · Porcelain Stoneware · Grès Porcelainé · Керамогранит



Cosmos indoor

venus]

1 Base · 120x120 cm - C-1 / R9

2 Peldaño ML120 · 33x120x3 cm - C-1 / R9

3 Tabica · 14,5x120 cm - C-1 / R9

4 Base cosmos corten · 60x120 cm - C-1 / R9



Cosmos indoor

corten]

- 1 Base · 120x120 cm - C-1 / R9
- 2 Base lizana haya · 20x120 cm - C-1 / R9
- 3 Peldaño recto 120 · 33x120x3 cm - C-1 / R9
- 4 Tabica · 14,5x120 cm - C-1/R9



Cosmos indoor

steel]

- 1 Base · 120x120 cm - C-1 / R9
- 2 Peldaño recto 120 · 33x120x3 cm - C-1 / R9
- 3 Remate peldaño recto · 3x33 cm
- 4 Tabica · 14,5x120 cm - C-1/R9
- 5 Base cosmos corten · 120x120 cm - C-1 / R9



Cosmos indoor

steel] 1 Base · 120x120 cm - C-1 / R9
2 Base cosmos corten · 60x120 cm - C-1 / R9

3 Peldaño recto 120 · 33x120x3 cm - C-1 / R9
4 Tabica · 14,5x120 cm - C-1 / R9



Cosmos indoor

venus] 1 Base · 60x120 cm - C-1 / R9
2 Peldaño recto 120 · 33x120x3 cm - C-1 / R9

3 Tabica · 14,5x120 cm - C-1 / R9

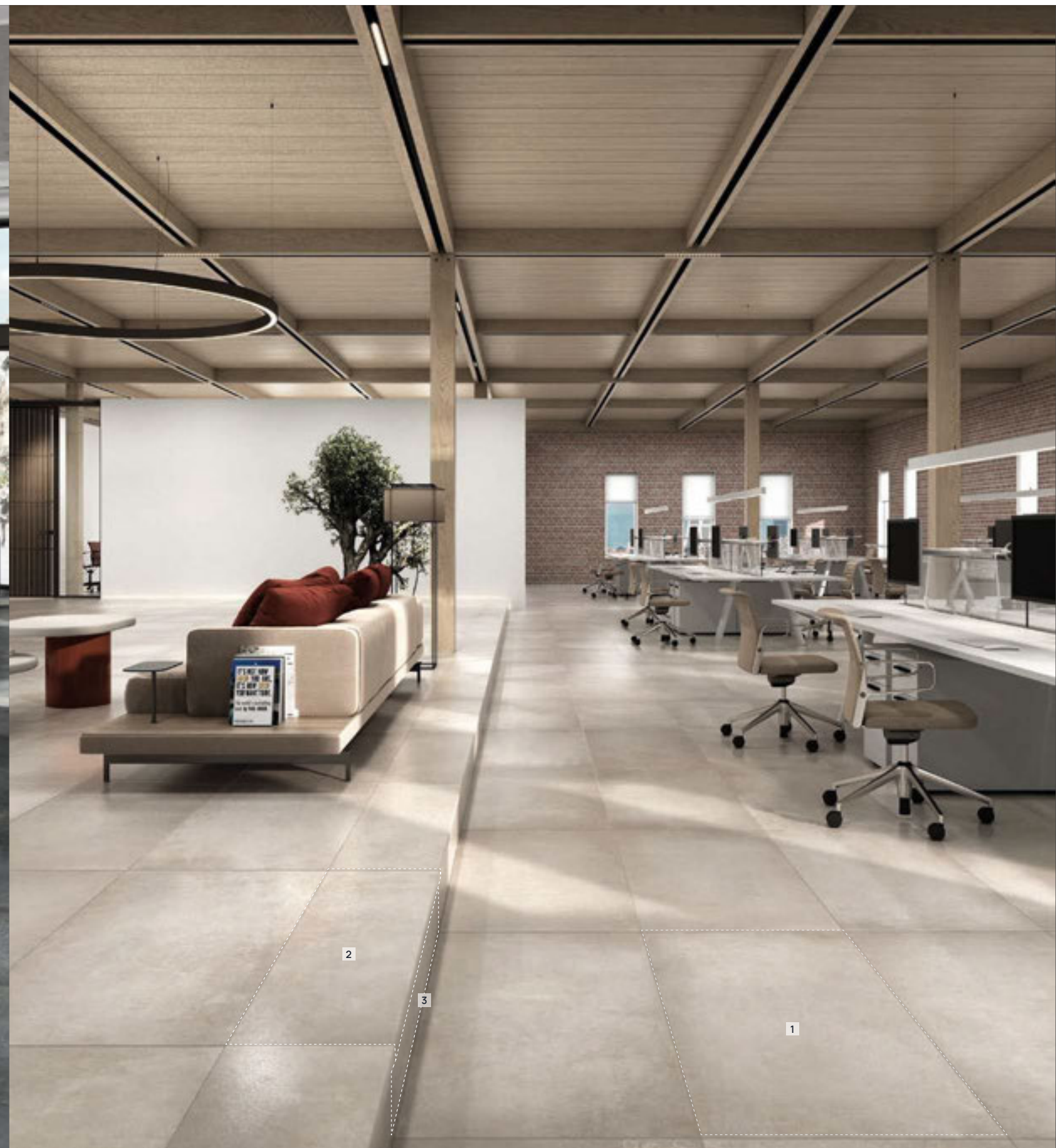

Cosmos indoor



Cosmos indoor

copper]

- 1 Base · 60x120 cm - C-1 / R9
- 2 Peldaño recto 120 · 33x120x3 cm - C-1 / R9
- 3 Tabica · 14,5x120 cm - C-1 / R9

corten]

- 1 Base · 60x120 cm - C-1 / R9
- 2 Peldaño recto 120 · 33x120x3 cm - C-1 / R9
- 3 Tabica · 14,5x120 cm - C-1 / R9
- 4 Base lizana haya · 20x120 cm - C-1 / R9
- 5 Peldaño recto 120 lizana haya · 33x120x3 cm - C-1 / R9
- 6 Tabica lizana haya · 14,5x120 cm - C-1 / R9



Cosmos in&out+skimmer pool coping

venus]

- 1 Base - 33x66,5 cm - C-3 / R11+C
- 2 Base - 33x66,5 cm - C-1 / R9

- 3 Base - 60x120 cm - C-1 / R9
- 4 Peldaño recto 120 - 33x120x3 cm - C-3/ R11+C

- 5 Tabica - 14,5x120 cm - C-1 / R9



Cosmos in&out+skimmer pool coping



corten]

- 1 Base · 33x66,5 cm - C-3 / R11+C
- 2 Base · 60x120 cm - C-1 / R9

- 3 Peldaño recto 120 · 33x120x3 cm - C-3 / R11+C
- 4 Base imperial arian · 60x120 cm - C-1 / R9





URBAN

Ópera
in&out&in



ESPAÑOL / ENGLISH

Ópera serie in&out&in

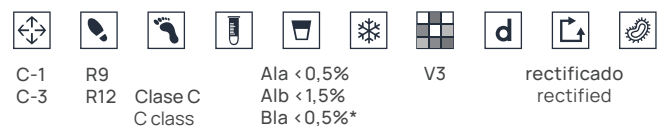

acabados. finishes



Ivory Light Silver Iron



120x120 cm*
47.2" x 47.2"

10 mm
C-1 R9
C-3 R12 C Class



60x120 cm*
23.6" x 47.2"

9 mm
C-1 R9
C-3 R12 C Class



14,5x120 cm*
5.7" x 47.2"

9 mm
C-1 R9



33x66,5 cm
13.0" x 26.2"

10 mm
C-1 R9
C-3 R12 C Class

Alb / Gres Extruido · Extruded Klinker · Grès Extrudé · Экструдированный Керамогранит
Ala / Gres Porcelánico Extruido · Extruded Porcelain Stoneware · Grès Porcelainé Extrudé · Экструдированный Керамогранит
*Bla / Gres Porcelánico · Porcelain Stoneware · Grès Porcelainé · Керамогранит

piezas piscina. pool pieces

	<p>Borde skimmer 45 x 75 x 3 cm 17.7" x 29.5" x 1.2"</p> <p>rectificado. rectified C-3 R12 C</p> <p>3D design Continuidad gráfica en parte trasera. Digitally printed backside.</p>
	<p>Borde desbordante 28 x 66,5 cm 11.0" x 26.2"</p> <p>rectificado. rectified C-3 R12 C</p>
	<p>Ángulo desbordante 31 x 31 cm 12.2" x 12.2"</p> <p>rectificado. rectified C-3 R12 C</p>
	<p>Rejilla 24,5 x 24,5 cm 9.6" x 9.6"</p> <p>rectificado. rectified C-3 R12 C</p>
	<p>Ángulo rejilla izda./dcha. 33 x 33 cm 13.0" x 13.0"</p> <p>rectificado. rectified C-3 R12 C</p>
	<p>Media caña 4 4,2 x 33 cm 1.7" x 13.0"</p>
	<p>Arista 3 3,3 x 33 cm 1.3" x 13.0"</p>
	<p>Uña media caña 4 4,2 x 4,2 cm 1.7" x 1.7"</p>
	<p>Uña arista 3 3,3 x 3,3 cm 1.3" x 1.3"</p>

peldaños y rodapiés. steps&skirtings

	<p>Peldaño recto 120 33 x 120 x 3 cm 13.0" x 47.2" x 1.2"</p> <p>12 mm rectificado. rectified C-1 R9 C-3 R12 C</p>
	<p>Remate peldaño recto 3 x 33 cm 1.2" x 13.0"</p> <p>7,5 mm</p>
	<p>Zanquín ingletado recto* 59,6 x 59,6 cm 23.5" x 23.5"</p> <p>11 mm</p> <p>*sólo color Light. only Light color</p>
	<p>Zanquín recto izda./dcha.* 17,5 x 42,3 cm 6.9" x 16.7"</p> <p>7,5 mm</p> <p>*Colores Ivory, Silver, Iron. Ivory, Silver, Iron colors</p>
	<p>Rodapié 9 x 60 cm 3.6" x 23.6"</p> <p>11 mm</p>

Ópera indoor

ivory] **1** Base · 120x120 cm - C-1 / R9 **2** Peldaño recto 120 · 33x120x3 cm - C-1 / R9 **3** Tabica · 14,5x120 cm - C-1 / R9



Ópera indoor

light]

- 1 Base · 120x120 cm - C-1 / R9
- 2 Peldaño recto 120 · 33x120x3 cm - C-1 / R9
- 3 Tabica · 14,5x120 cm - C-1 / R9

iron]

- 1 Base · 60x120 cm - C-1 / R9
- 2 Base yoho oak · 25x150 cm - C-1 / R9



Ópera outdoor+overflow pool coping

iron] 1 Base · 120x120 cm - C-3 / R12+C
2 Base · 33x66,5 cm - C-1 / R9

3 Borde desbordante · 28x66,5 cm - C-3 / R12+C
4 Rejilla · 24,5x24,5 cm - C-3 / R12+C

5 Áng. rejilla · 33x33 cm - C-3 / R12+C
6 Áng. desbordante · 31x31 cm - C-3 / R12+C

7 Peldaño recto 120 · 33x120x3 cm - C-3/ R12+C
8 Tabica · 14,5x120 cm - C-1 / R9

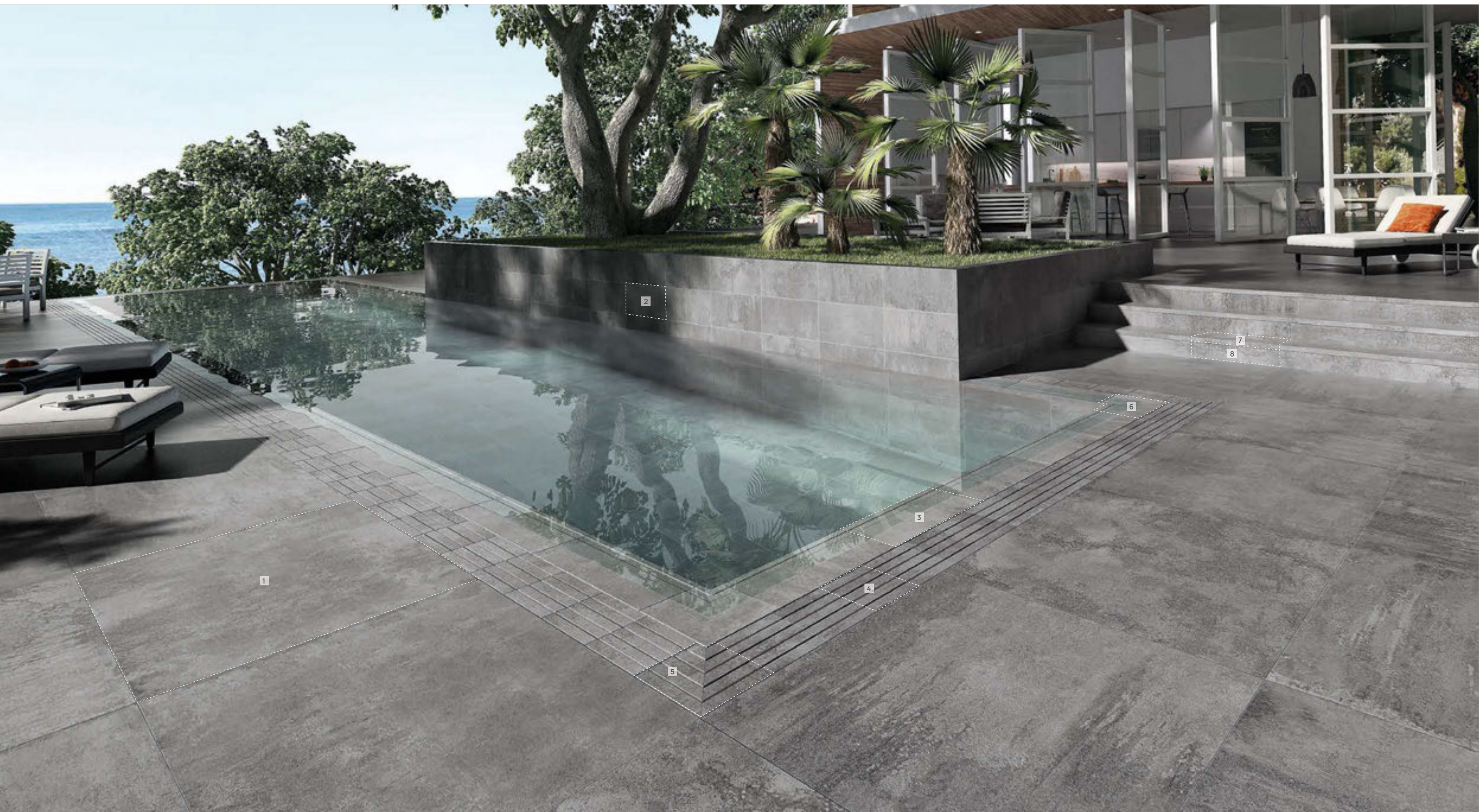

Ópera outdoor+overflow pool coping



ivory]

- 1 Base · 120x120 cm - C-3 / R12+C
- 2 Base · 33x66,5 cm - C-3 / R12+C
- 3 Borde desbordante · 28x66,5 cm - C-3 / R12+C
- 4 Áng. desbordante · 31x31 cm - C-3 / R12+C
- 5 Rejilla · 24,5x24,5 cm - C-3 / R12+C
- 6 Áng. rejilla · 33x33 cm - C-3 / R12+C

iron]

- 1 Base · 120x120 cm - C-3 / R12+C
- 2 Base · 60x120 cm - C-1 / R9
- 3 Borde desbordante · 28x66,5 cm - C-3 / R12+C
- 4 Áng. desbordante · 31x31 cm - C-3 / R12+C
- 5 Rejilla · 24,5x24,5 cm - C-3 / R12+C
- 6 Áng. rejilla · 24,5x33 cm - C-3 / R12+C
- 7 Media caña 4 · 4,2x33 cm
- 8 Peld. recto 120 · 33x120x3 cm - C-3 / R12+C
- 8 Tabica · 14,5x120 cm - C-1 / R9

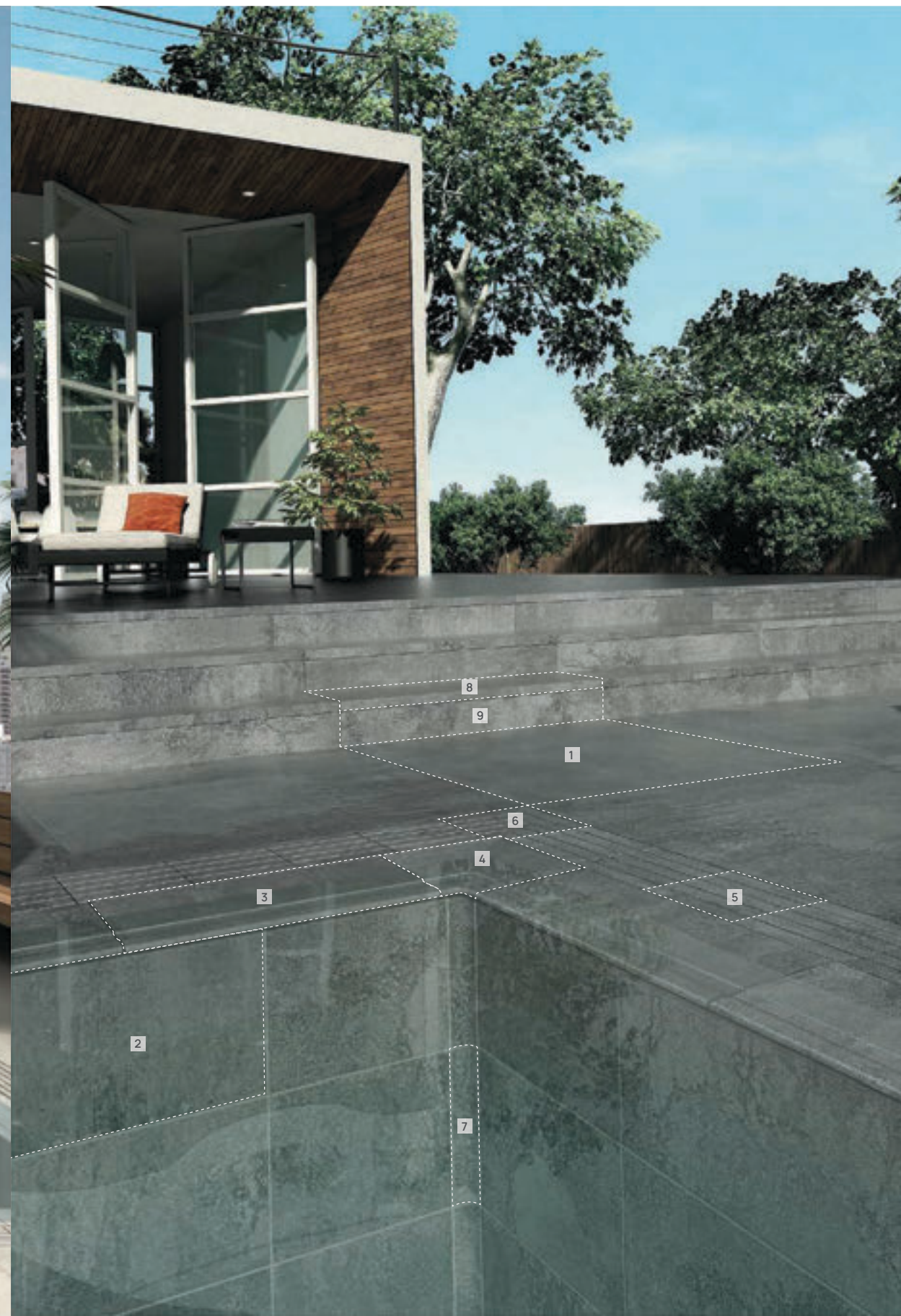

Borde desbordante
28 x 66,5 cm - 11.0" x 26.2"

C-3 R12 C



Ángulo desbordante
31 x 31 cm - 12.2" x 12.2"

C-3 R12 C



Rejilla
24,5 x 24,5 cm - 9.6" x 9.6"

C-3 R12 C



Áng. rejilla izda./dcha.
33 x 33 cm - 13.0" x 13.0"

C-3 R12 C



Media caña 4
4,2 x 33 cm - 1.7" x 13.0"



Peldaño recto 120
33 x 120 x 4 cm - 13.0" x 47.2" x 1.6"

C-3 R12 C



Ópera in&out+skimmer pool coping



ivory]

1 Base · 60x120 cm - C-3 / R12+C

2 Peldaño recto 120 · 33x120x3 cm - C-3 / R12+C

3 Base · 60x120 cm - C-1 / R9

4 Peldaño recto 120 · 33x120x3 cm - C-1 / R9

5 Tabica · 14,5x120 cm - C-1 / R9



Ópera in&out+skimmer pool coping



Ópera in&out+infinity skimmer pool coping

light]

- 1 Base · 60x120 cm - C-1 / R9
- 2 Base · 60x120 cm - C-3 / R12+C
- 3 Peldaño recto 120 · 33x120x3 cm - C-3 / R12+C
- 4 Borde skimmer · 45x75x3 cm - C-3 / R12+C
- 5 Tabica · 14,5x120 cm - C-1 / R9

silver]

- 1 Base · 60x120 cm - C-1 / R9
- 2 Base · 120x120 cm - C-3 / R12+C
- 3 Base · 60x120 cm - C-3 / R12+C
- 4 Borde skimmer · 45x75x3 cm - C-3 / R12+C
- 5 Media caña 4 · 4,2x33 cm
- 6 Uña media caña 4 · 4,2x4,2 cm



Borde skimmer
45 x 75 x 3 cm
17.7" x 29.5" x 1.2"

C-3 R12 C



Media caña 4
4,2 x 33 cm
1.7" x 13.0"



Uña media caña 4
4,2 x 4,2 cm
1.7" x 1.7"

6





URBAN

Mediterráneo

in&out



ESPAÑOL



ENGLISH



FRANÇAIS

Mediterráneo serie in&out

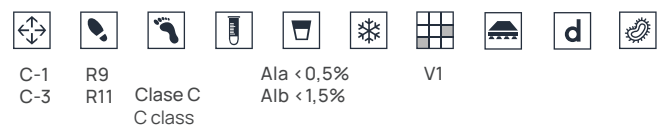

acabados. finishes



Arena

Grafito



33x66,5 cm
13.0" x 26.2"

⊠ 10 mm
 ☒ C-1 ☒ R9
 ☒ C-3 ☒ R11 ☒ C Class



33x33 cm
13.0" x 13.0"

⊠ 10 mm
 ☒ C-1 ☒ R9
 ☒ C-3 ☒ R11 ☒ C Class

piezas piscina. pool pieces

	<p>Peldaño fiorentino 33 x 33 x 3 cm 13.0" x 13.0" x 1.2" ⊠ 12 mm</p> <p>☒ C-1 ☒ R9 ☒ C-3 ☒ R11 ☒ C</p>
	<p>Cartabón fiorentino 33 x 33 x 3 cm 13.0" x 13.0" x 1.2" ⊠ 14 mm</p> <p>☒ rectificado. rectified ☒ C-1 ☒ R9 ☒ C-3 ☒ R11 ☒ C</p>
	<p>Peldaño recto 33 x 33 x 3 cm 13.0" x 13.0" x 1.2" ⊠ 12 mm</p> <p>☒ C-1 ☒ R9 ☒ C-3 ☒ R11 ☒ C</p>
	<p>Zanquín ingletado fiorentino izda./dcha.* 32,8 x 32,8 cm 12.9" x 12.9" ⊠ 11 mm</p> <p>*Sólo color arena. Only arena color.</p>
	<p>Zanquín ingletado recto izda./dcha.* 32,8 x 32,8 cm 12.9" x 12.9" ⊠ 11 mm</p> <p>*Sólo color arena. Only arena color.</p>
	<p>Zanquín fiorentino izda/dcha. 17,5x39,5 cm 6.9"x15.6" ⊠ 7,5 mm</p> <p>*Sólo color grafito. Only grafito color</p>
	<p>Zanquín recto izda./dcha. 17,5x42,3 cm 6.9"x16.7" ⊠ 11 mm</p> <p>*Sólo color grafito. Only grafito color</p>
	<p>Rodapié 9 x 33 cm 3.6" x 13.0"</p>

vierteaguas y pasamanos. window sills & handrails

	<p>Vierteaguas 12 x 33 x 3 cm 3.6" x 13.0" x 1.2" ⊠ 12 mm</p>
	<p>Pasamanos 12* 12,5 x 66,5 x 4 cm 4.9" x 26.2" x 1.6"</p> <p>*Medidas interiores. Inner measures.</p>
	<p>Pasamanos 15* 15,5 x 66,5 x 4 cm 6.1" x 26.2" x 1.6"</p> <p>*Medidas interiores. Inner measures.</p>

Mediterráneo outdoor

arena]

- 1 Base · 33x66,5 cm - C-3 / R11+C
- 2 Peldaño recto · 33x33x3 cm - C-3 / R11+C



Mediterráneo indoor

grafito]

- 1 Peldaño recto · 33x33x3 cm - C-1 / R9
- 2 Zanquín recto izda. · 17,5x42,3 cm





STONE

Bedford
in&out&in



ESPAÑOL



ENGLISH

Bedford serie

in&out&in



acabados. finishes



White

Sand

Pearl

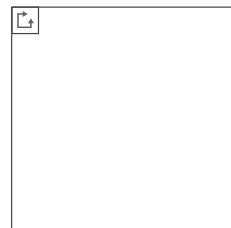

120x120 cm*
47.2" x 47.2"

9 mm
C-1 R9
C-3 R12 C Class



60x120 cm*
23.6" x 47.2"

9,2 mm
C-1 R9
C-3 R12 C Class



14,5x120 cm*
5.7" x 47.2"

9,2 mm
C-1 R9



33x66,5 cm
13.0" x 26.2"

10 mm
C-1 R9
C-3 R12 C Class



33x33 cm
13.0" x 13.0"

10 mm
C-1 R9
C-3 R12 C Class

piezas piscinas. pool pieces



Borde skimmer
45 x 120 x 3 cm
17.7" x 47.2" x 1.2"

rectificado. rectified
C-3 R12 C

3D design. Continuidad gráfica en parte trasera. Digitally printed backside.



Borde desbordante
28 x 66,5 cm
11.0" x 26.2"

rectificado. rectified
C-3 R12 C

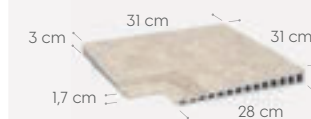

Ángulo desbordante
31 x 31 cm
12.2" x 12.2"

rectificado. rectified
C-3 R12 C

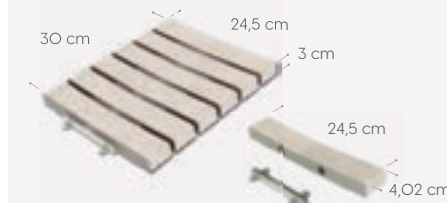

Rejilla modular
24,5 x 30 cm
9.6" x 11.8"

rectificado. rectified
C-3 R12 C

Set de 6 piezas desmontables de 4,02 x 24,5 cm.
Set of 6 detachable pieces 4,02 x 24,5 cm.



Ángulo rejilla modular
30 x 30 cm
11.8" x 11.8"

rectificado. rectified
C-3 R12 C

Set de 2 piezas (izda./dcha.) Two pieces set (left/right)



Media caña 8
7,7 x 66,5 cm
3.0" x 26.2"



Arista 8
7,7 x 66,5 cm
3.0" x 26.2"

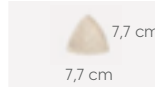

Uña media caña 8
7,7 x 7,7 cm
3.0" x 3.0"

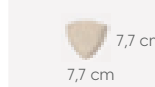

Uña arista 8
7,7 x 7,7 cm
3.0" x 3.0"

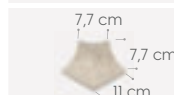

Ángulo arista 8
7,7 x 7,7 x 11 cm
3.0" x 3.0" x 4.3"

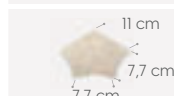

Ángulo media caña 8
7,7 x 7,7 x 11 cm
3.0" x 3.0" x 4.3"

peldaños y rodapiés. steps&skirtings

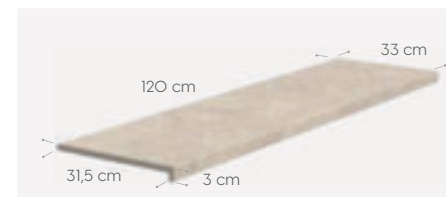

Peldaño recto 120
33 x 120 x 3 cm
13.0" x 47.2" x 1.2"

12 mm
rectificado. rectified
C-1 R9
C-3 R12 C

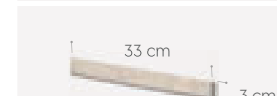

Remate peldaño recto
3 x 33 cm
1.2" x 13.0"

7,5 mm

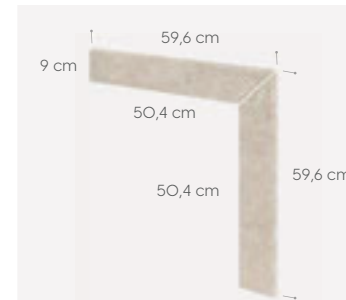

Zanquín ingletado recto
59,6 x 59,6 cm
23.5" x 23.5"

11 mm



Rodapié
9 x 60 cm
3.6" x 23.6"

11 mm

Bedford in&out



sand] 1 Base - 60x120 cm - C-1 / R9
2 Provenza bianco - 120x120 cm - C-1 / R9

3 Provenza bianco - 120x120 cm - C-3 / R12



Bedford in&out&in+skimmer pool coping



pearl]

- 1 Base - 120x120 cm - C-1 / R9
- 2 Base - 33x33 cm - C-3/ R12+C

- 3 Borde skimmer - 45x120x3 cm - C-3 / R12+C



Bedford out&in+skimmer pool coping



pearl]

- 1 Base · 60x120 cm - C-3 / R12+C
- 2 Borde skimmer · 45x120x3 cm - C-3 / R12+C
- 3 Peldaño recto 120 · 33x120x3 cm - C-3/ R12+C
- 4 Tabica · 14,5x120 cm - C-1 / R9
- 5 Base · 60x120 cm - C-1 / R9



Bedford in&out&in+skimmer pool coping

white]

1 Base · 60x120 cm - C-3 / R12+C

3 Peldaño recto 120 · 33x120x3 cm - C-3/ R12+C

2 Borde skimmer · 45x120x3 cm - C-3 / R12+C

4 Tabica · 14,5x120 cm - C-1 / R9



Bedford in&out&in+skimmer pool coping



- sand]
- 1 Base - 120x120 cm - C-3 / R12+C
 - 2 Base - 120x120 cm - C-1 / R9
 - 3 Borde skimmer - 45x120x3 cm - C-3 / R12+C



2

1

3

3

Bedford in&out&in+overflow infinity pool coping

white]

1 Base · 120x120 cm - C-3 / R12+C

3 Áng. desbordante · 31x31 cm - C-3 / R12+C

5 Áng. rejilla modular · 30x30 cm - C-3 / R12+C

7 Áng. media caña 8 · 7,7x7,7x11 cm

9 Arista 8 · 7,7x66,5 cm

2 Borde desbordante · 28x66,5 cm - C-3 / R12+C

4 Rejilla modular · 24,5x30 cm - C-3 / R12+C

6 Base · 60x120 cm - C-3 / R12+C

8 Media caña 8 · 7,7x66,5 cm

10 Uña arista 8 · 7,7x7,7 cm





STONE

Ardenas

in&out



ESPAÑOL



ENGLISH



FRANÇAIS

Ardenas serie in&out

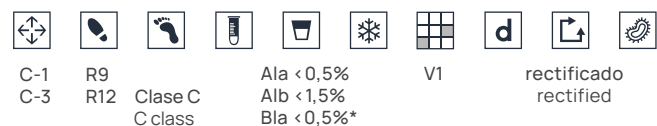

acabados. finishes



Marfil

Cromo

Gris

Antracita



Alb / Gres Extruido · Extruded Klinker · Grès Extrudé · Экструдированный Керамогранит
 Ala / Gres Porcelánico Extruido · Extruded Porcelain Stoneware · Grès Porcelainé Extrudé · Экструдированный Керамогранит
 *Bla / Gres Porcelánico · Porcelain Stoneware · Grès Porcelainé · Керамогранит

peldaños y rodapiés. steps&skirtings



piezas piscinas. pool pieces



Ardenas indoor

antracita]

1 Base · 120x120 cm - C-1 / R9

2 Peldaño recto 120 · 33x120x3 cm - C-1 / R9

3 Base lizana cerezo · 20x120 cm - C-1 / R9

4 Peldaño recto 120 lizana haya · 33x120x3 cm - C-1 / R9



Ardenas indoor

marfil]

- 1 Base · 120x120 cm - C-1 / R9
- 2 Peldaño recto 120 · 33x120x3 cm - C-1 / R9
- 3 Tabica · 14,5x120 cm - C-1 / R9
- 4 Zanquín ingletado recto · 59,6x59,6 cm
- 5 Rodapié · 9x60 cm

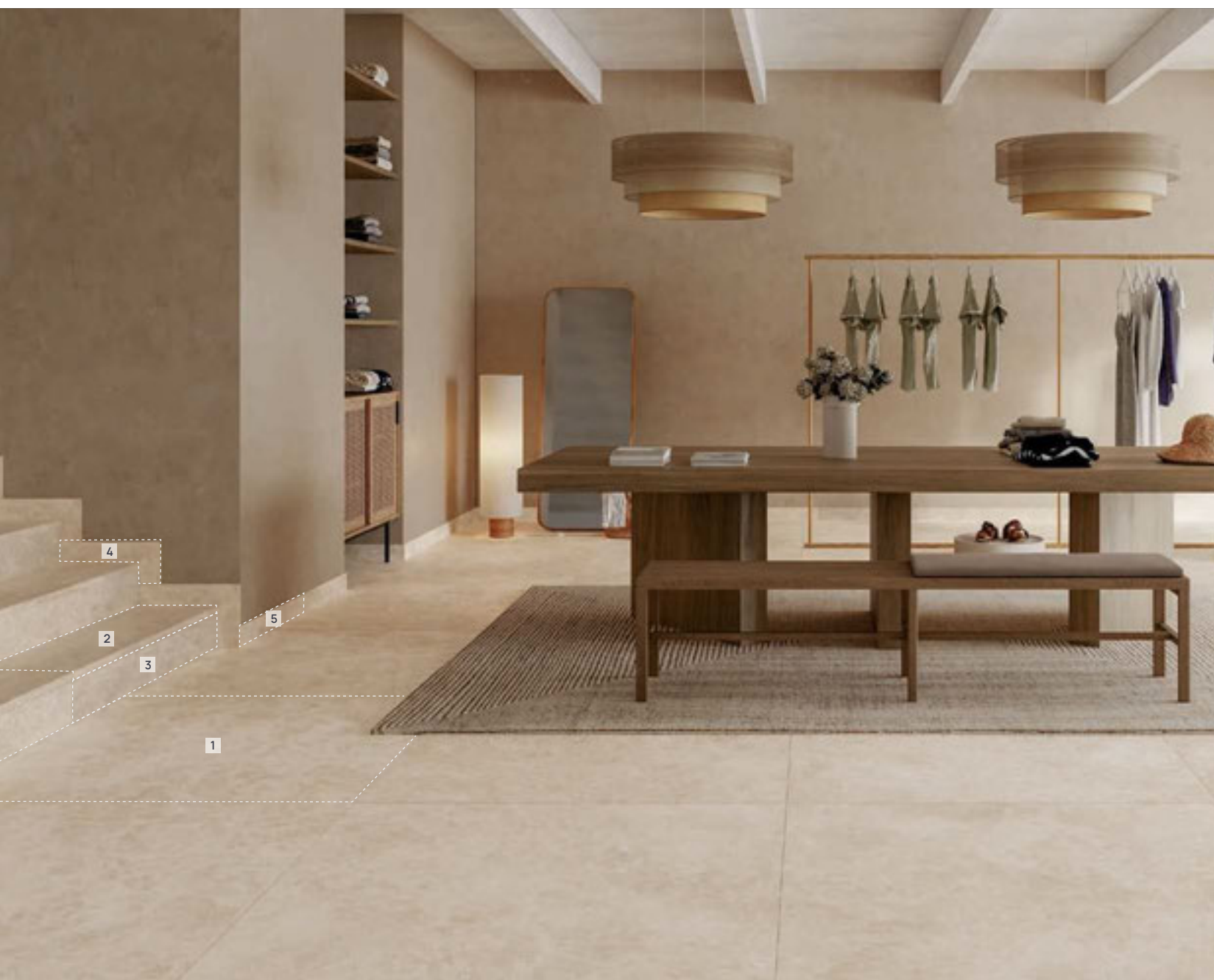

gris]

- 1 Base · 60x120 cm - C-1 / R9
- 2 Peldaño recto 120 · 33x120x3 cm - C-1 / R9
- 3 Tabica · 14,5x120 cm - C-1 / R9
- 4 Base ardenas antracita · 120x120 cm - C-1 / R9



Ardenas indoor

antracita]

- 1 Base · 60x120 cm - C-1 / R9
- 2 Peldaño recto 120 · 33x120x3 cm - C-1 / R9
- 3 Tabica · 14,5x120 cm - C-1 / R9
- 4 Base cosmos venus · 120x120 cm - C-1 / R9

gris]

- 1 Base · 120x120 cm - C-1 / R9
- 2 Peldaño recto 120 · 33x120x3 cm - C-1 / R9
- 3 Tabica · 14,5x120 cm - C-1 / R9
- 4 Base ardenas antracita · 120x120 cm - C-1 / R9
- 5 Base cosmos corten · 120x120 cm - C-1 / R9

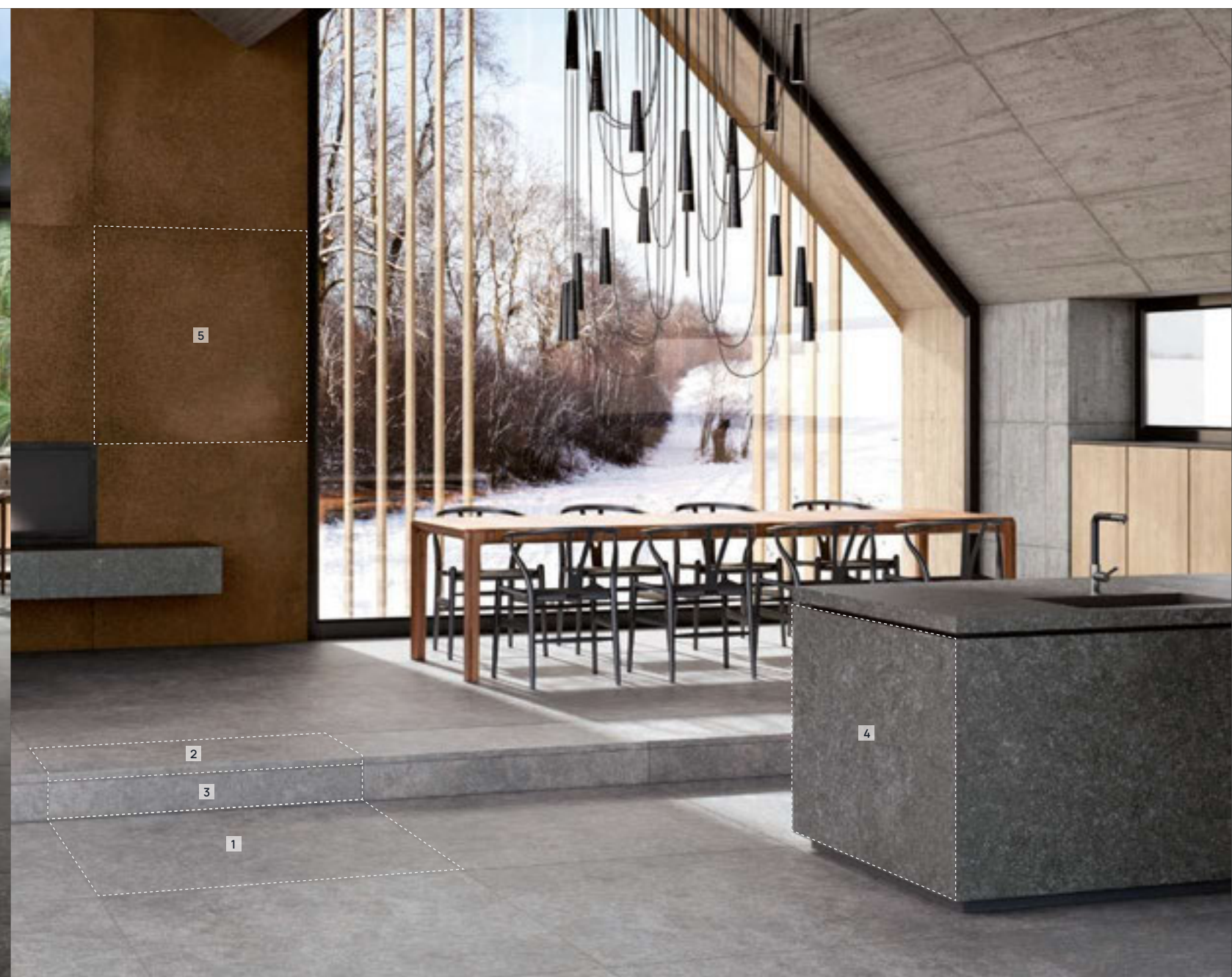

Ardenas in&out

cromo]

1 Base · 120x120 cm - C-1 / R9

2 Peldaño recto 120 · 33x120x3 cm - C-1 / R9

3 Tabica · 14,5x120 cm - C-1 / R9

4 Base · 60x120 cm - C-3 / R12+C

5 Base 20 · 60x120x2 cm espesorado - C-3 / R12+C



Ardenas in&out

cromo]

- 1 Base · 60x120 cm - C-1 / R9
- 2 Peldaño ML · 33x33x4 cm - C-3 / R12+C
- 3 Base · 33x33 cm - C-3 / R12+C



antracita]

- 1 Base · 33x33 cm - C-3 / R12+C
- 2 Base · 16,25x33 cm - C-3 / R12+C
- 3 Base · 16,25x16,25 cm - C-3 / R12+C
- 4 Peldaño ML · 33x33x4 cm - C-3 / R12+C



Ardenas in&out+skimmer pool coping

gris

- 1 Base · 60x120 cm · C-1 / R9
2 Base · 60x120 cm · C-3 / R12+C

- 3 Peldaño recto 120 gris · 33x120x3 cm · C-3/ R12+C
4 Borde skimmer ardenas cromo · 45x75x3 cm · C-3 / R12+C

- 5 Base ardenas cromo · 16,25x16,25 cm · C-3 / R12+C
6 Peldaño recto 120 ardenas cromo · 33x120x3 cm · C-3/ R12+C



Ardenas outdoor+skimmer pool coping

gris]

1 Base · 120x120 cm - C-3 / R12+C
2 Base · 60x120 cm - C-3 / R12+C

3 Base ardenas antracita · 60x120 cm - C1 / R9
4 Borde skimmer · 45x75x3 cm - C-3 / R12+C

5 Peldaño recto 120 · 33x120x3 cm - C-3 / R12+C
6 Tabica · 14,5x120 cm - C-1 / R9



Ardenas indoor+skimmer pool coping



marfil]

- 1 Base - 60x120 cm - C-3 / R12+C
- 2 Base - 120x120 cm - C-1 / R9

- 3 Borde skimmer - 45x75x3 cm - C-3 / R12+C

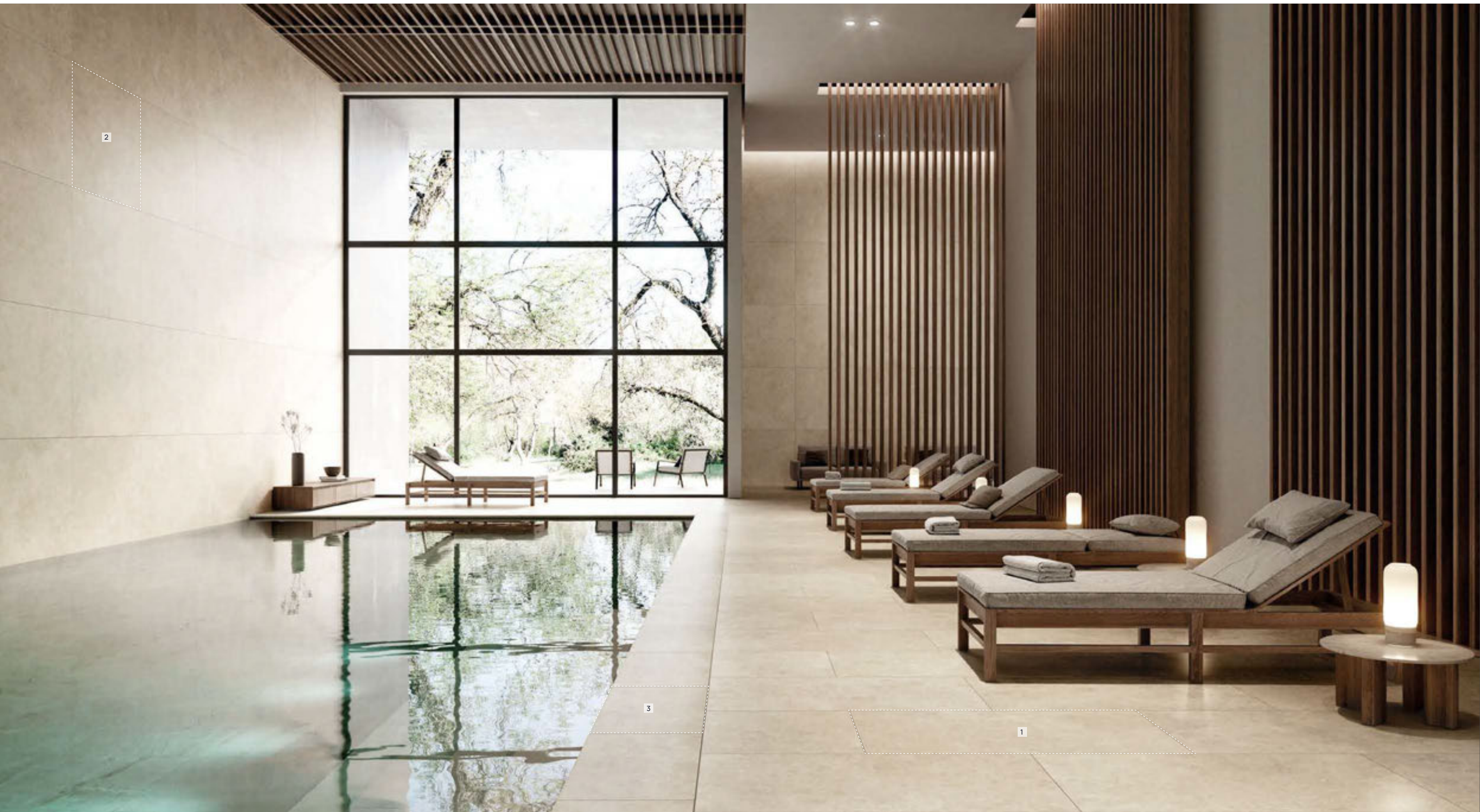

2

3

1

Ardenas outdoor+skimmer pool coping



- marfil]
- 1 Base · 60x120 - C-3 / R12+C
 - 2 Borde skimmer · 45x75x3 cm - C-3 / R12+C
 - 3 Peldaño ML · 33x33x4 cm - C-3 / R12+C
 - 4 Cartabón ML · 33x33x4 cm - C-3 / R12+C



Ardenas outdoor+skimmer pool coping



cromo]

- 1 Base · 120x120 cm - C-3 / R12+C
- 2 Borde skimmer · 45x75x3 cm - C-3 / R12+C
- 3 Peldaño recto · 33x120x3 cm - C-3 / R12+C
- 4 Tabica · 14,5x120 cm - C-1 / R9
- 5 Base ardenas gris · 60x120 cm - C-1 / R9

marfil]

- 1 Base · 33x66,5 cm - C-3 / R12+C
- 2 Borde skimmer · 45x75x3 cm - C-3 / R12+C
- 3 Peldaño recto · 33x120x3 cm - C-3 / R12+C
- 4 Base · 33x33 cm - C-3 / R12+C
- 5 Base · 16,25x33 cm - C-3 / R12+C
- 6 Base · 16,25x16,25 cm - C-3 / R12+C



Borde skimmer
45 x 75 x 3 cm - 17.7" x 29.5" x 1.2"

C-3 R12 C

2



Peldaño recto 120
33 x 120 x 4 cm - 13.0" x 47.2" x 1.6"

C-3 R12 C

3



Ardenas outdoor+skimmer pool coping



marfil]

- 1 Base · 33x66,5 cm - C-3 / R12+C
- 2 Base · 33x33 cm - C-3 / R12+C

- 3 Peldaño ML · 33x33x4 cm - C-3 / R12+C
- 4 Base ardenas antracita · 16,25x16,25 cm - C-3 / R12+C



1
2

3

4



STONE

Ardenas 
outdoor



ESPAÑOL



ENGLISH



FRANÇAIS

Ardenas 20 serie outdoors

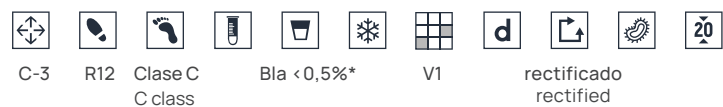

acabados. finishes

gris] 1 Base 20 · 60x120x2 cm espesorado - C-3 / R12+C



Marfil

Cromo

Gris

Antracita



60x120x2 cm*
23.6" x 47.2"

20 mm espesorado - 2 cm outdoor
C-3 R12 C Class

*Bla / Gres Porcelánico · Porcelain Stoneware · Grès Porcelainé · Керамогранит

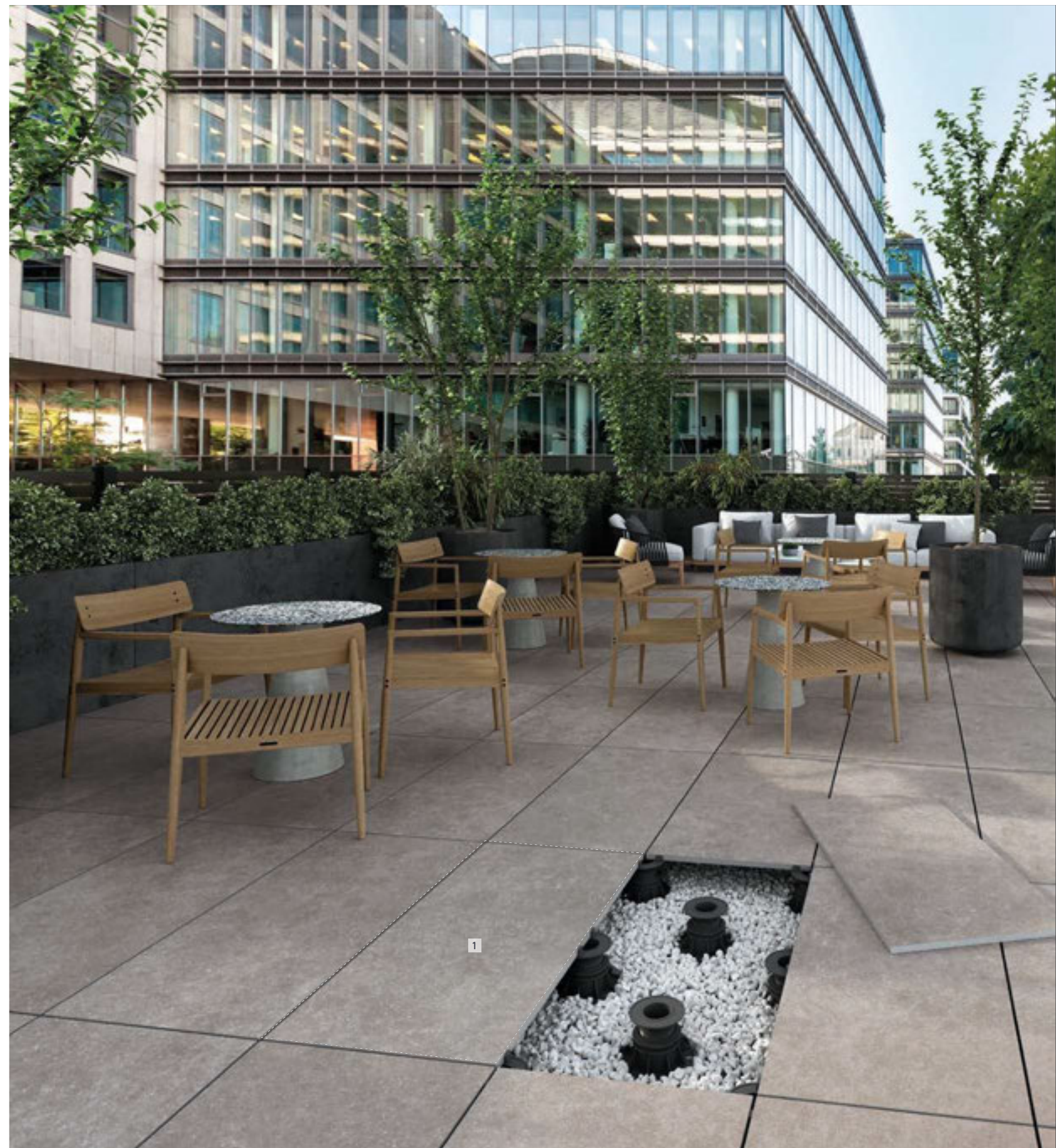

Ardenas 20 outdoors



gris]

- 1 Base 20 · 60x120x2 cm espesorado - C-3 / R12+C
- 2 Peldaño ML · 33x33x4 cm - C-3 / R12+C

- 3 Cartabón ML · 33x33x4 cm - C-3 / R12+C
- 4 Base · 60x120 cm - C-3 / R12+C

- 5 Base · 60x120 cm - C-1 / R9



Ardenas 20 serie

Ventajas.

Advantages. Avantages. Преимущества.



Fácil instalación

Easy installation · Installation facile · Простая установка



Fácil limpieza

Easy to clean · Nettoyage facile · Легкая очистка



Antideslizante CLASE 3 - R 12/C

CLASS 3-R12 /C anti-slip properties · Antidérapant
CLASSE 3 - R12/C ·
Коэффициент противоскольжения 3-R12/C



Resistente al musgo y hongos

Resistant to mould and fungus · Résistant aux mousses
et aux champignons · Устойчивость к мхам и грибкам



Bajo coste de mantenimiento

Low maintenance cost · Faible coût d'entretien ·
Низкая стоимость обслуживания



Resistente a las manchas

Stain resistant · Résistant aux taches ·
Устойчивость к пятнам



Resistente a los cambios de temperatura

Resistant to temperature variations ·
Résistant aux changements de température ·
Устойчивость к изменениям температуры



Fácil sustitución de piezas

Easy parts replacement · Remplacement facile des pièces ·
Простая замена деталей



Resistente al rayado

Scratch resistant · Résistant aux rayures ·
Устойчивость к царапинам



Inalterable a la luz solar

Unalterable to sunlight · Inaltérable au soleil ·
Не поддается воздействию солнечного света



Resistente a las heladas

Frost resistant · Résistant au gel · Морозостойкость



Resistente a las sales, ácidos y químicos

Resistant to salts, acids and chemicals · Résistant aux
sels, aux acides et aux produits chimiques ·
Устойчивость к воздействию солей, кислот и химикатов



Respetuoso con el medioambiente

Environmentally friendly · Respect de l'environnement ·
Экологически чистый



No necesita sellado

No sealing required · Pas d'étanchéité requise ·
Уплотнение не требуется

Usos.

Uses. Utilisations. Используется.

Ámbito residencial

Residential sector · Secteur résidentiel · Жилой сектор



Jardines y patios

Gardens and courtyards · Jardins et cours ·
Сады и внутренние дворы



Terrazas

Terraces · Terrasses · Террасы



Piscinas

Swimming pools · Piscines · Плавательные бассейны



Escaleras

Stairs · Escaliers · Лестницы

Ámbito público

Public sector · Secteur public · Публичная сфера



Áreas públicas exteriores

Outdoor public areas · Espaces publics extérieurs ·
Открытые общественные зоны



Restaurantes exteriores

Outdoor restaurants · Restaurants en plein air ·
Рестораны на открытом воздухе



Bares y establecimientos de playa

Bars and beach establishments · Bars et établissements de
plage · Бары и пляжные заведения



Piscinas públicas

Public swimming pools · Piscines publiques ·
Общественные плавательные бассейны



Características técnicas.

Technical data. Caractéristiques techniques. Технические характеристики.

NORMA TEST STANDARD СТАНДАРТ	DESCRIPCIÓN DESCRIPTION DESCRIPTION ОПИСАНИЕ	REQUISITOS STANDARDS EXIGENCES РЕКВИЗИТЫ	VALOR MEDIO AVERAGE VALUE VALEUR MOYENNE СРЕДНЯЯ СТОИМОСТЬ
ISO 10545-2	Dimensiones / Sizes / Dimensions / Размеры		
	Longitud y anchura / Length and width / Longueur et largeur / Длина и ширина	± 0,6% ± 2 mm	
	Espesor / Thickness / Épaisseur / Толщина	± 5,0% ± 0,5 mm	garantizado guaranteed garanti
	Rectitud de los lados / Straightness of sides / Rectitude des côtés / Прямызна сторон	± 0,5% ± 1,5 mm	Гарантированно
	Ortogonalidad / Rectangularity / Orthogonalité / Ортогональность	± 0,5% ± 2 mm	
	Planaridad / Surface Flatness / Planarité / Планарность	± 0,5% ± 2 mm	
ISO 10545-3	Absorción de agua / Water absorption / Absorption d'eau / Водопоглощение	< 0,5 %	< 0,5 %
ISO 10545-4	Fuerza de rotura / Breaking strength / Résistance à la rupture / Прочность на отрыв	≥ 11.000 N	≥ 11.000 N
ISO 10545-4	Resistencia a la flexión / Modulus of rupture / Résistance à la flexion / Сопротивление на изгиб	≥ 35 N/mm ²	> 35 N/mm ²
ISO 10545-7	Resistencia a la abrasión (pei) / Deep abrasion resistance / Résistance à l'abrasion / Стойкость к истиранию поверхности	1-5	4 marfil/cromo/gris 2 antracita
ISO 10545-9	Resistencia al choque térmico / Thermal shock resistance / Résistant aux variation thermiques / Стойкость к тепловым перепадам	exigida required nécessaire требуется	garantizado guaranteed garanti Гарантированно
ISO 10545-12	Resistencia a la helada / Frost resistance / Résistance au gel / морозостойкость	exigida required nécessaire требуется	garantizado guaranteed garanti Гарантированно
ISO 10545-13	Resistencia a los agentes químicos / Chemical resistance / Résistance aux produits chimiques / Стойкость к воздействию химикатов	mínimo B minimum B минимум B	A-LA-HA
ISO 10545-14	Resistencia a las manchas / Stain resistance / Résistance aux taches / Устойчивость к образованию пятен	mínimo clase 3 minimum class3 classe 3 minimum минимум класс 3	clase 5 class 5 classe 5 класс 5
EN 16165 Anexo C	Resistencia al deslizamiento (péndulo.) / Anti-slip resistance (pendulum) / Résistance au glissement (pendulum) / Сопротивление скольжению (маятник)	Exigida C.T.E. C.T.E. required C.T.E. obligatoire Требуется C.T.E.	CLASE 3 CLASS 3 CLASSE 3 КЛАСС 3
EN 16165 Anexo B	Resistencia al deslizamiento (rampa pie calzado) / Anti-slip resistance (ramp) / Résistance au glissement (pied chaussé) / Сопротивление скольжению (если ходит обутым)	-	R12
EN 16165 Anexo A	Resistencia al deslizamiento (rampa pie descalzo) / Anti-slip resistance (bare foot) / Résistance au glissement (pied nu) / Сопротивление скольжению (босые ноги)	-	CLASE C C Class CLASSE C КЛАСС C

Sistemas de colocación.

Installation systems. Systèmes de positionnement. Системы установки.

Colocación sobre grava o arena

Laying on gravel or sand · Pose sur du gravier ou du sable · Укладка на гравий или песок



Colocación sobre plots

Installation on plots · Placement sur plots · Размещение на участках



Colocación sobre césped

Laying on grass · Couché sur l'herbe · Лежать на траве



Colocación tradicional

Thin set installation · Placement traditionnel · Традиционное размещение



Ardenas outdoors+pools



cromo]  Base 20 · 60x120x2 cm - espesorado - C-3 / R12+C  Borde skimmer · 45x75x3 cm - C-3 / R12+C



Colocación en perímetros. Placement on perimeters · Placement sur les périmètres · Размещение по периметру

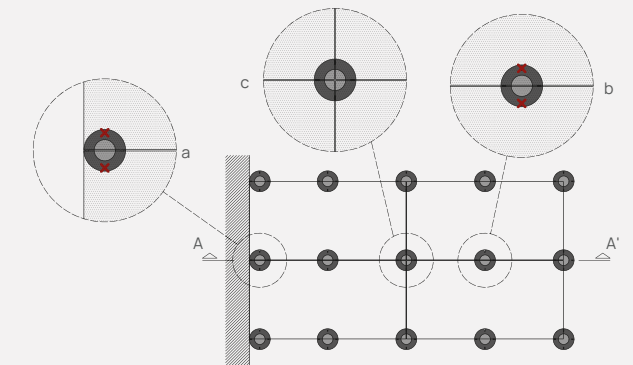

a-b. Corte 2 pestañas separadas. Cut 2 separate tabs · Coupez 2 onglets séparés · Вырежьте 2 отдельные вкладки

c. Sin corte de pestañas separadas. No cutting of separate eyelashes · Pas de coupe de cils séparés · Без подстригания отдельных ресниц

Sección vertical tipo A-A'. Vertical section type A-A' · Section verticale de type A-A' · Тип вертикальной секции A-A'

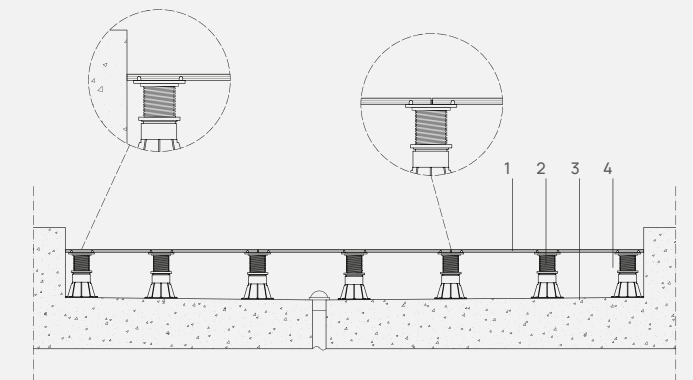

- 1. Baldosa cerámica 120x60 cm. Ceramic tile 120x60 cm · Carreau de céramique 120x60 cm · Керамическая плитка 120x60 см
- 2. Estructura elevada. PLOTS regulables. Elevated structure. adjustable plots · Ouvrage surélevé, parcelles ajustables · Эстакадная конструкция. Регулируемые участки
- 3. Formación de pendientes. Slope formation · Formation de pente · формирование склона
- 4. Cámara de aire. Air chamber · Chambre à air · Воздушная камера

Posición de plots. Plot position · Position du tracé · Позиция участка

Uso privado. Private use · Usage privé/Частное использование

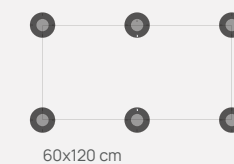

Uso público. Public use · Usage public/Общественное использование

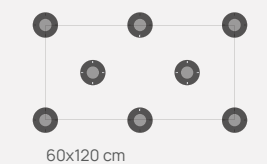

60x120 cm

60x120 cm



STONE

Albaroc

in&out



ESPAÑOL / ENGLISH

Albaroc serie in&out

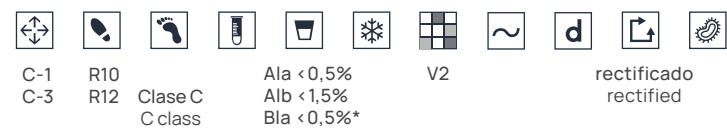

acabados. finishes



Boal

Galena

Hulla

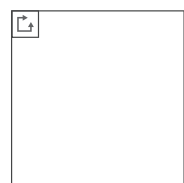

100x100 cm*
39.4" x 39.4"

10 mm
C-1 R10
C-3 R12 C Class



14,5x120 cm*
5.7" x 47.2"

9 mm
C-1 R10



33x66,5 cm
13.0" x 26.2"

10 mm
C-1 R10
C-3 R12 C Class



33x33 cm
13.0" x 13.0"

10 mm
C-1 R10
C-3 R12 C Class

peldaños y rodapiés. steps&skirtings

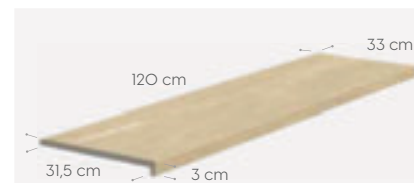

Peldaño recto 120
33 x 120 x 3 cm
13.0" x 47.2" x 1.2"

12 mm
rectificado. rectified
C-3 R12 C

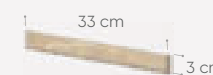

Remate peldaño recto
3 x 33 cm
1.2" x 13.0"

7,5 mm

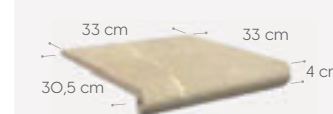

Peldaño ML
33 x 33 x 4 cm
13.0" x 13.0" x 1.6"

13 mm
C-3 R12 C



Cartabón ML
33 x 33 x 4 cm
13.0" x 13.0" x 1.6"

14 mm
rectificado. rectified
C-3 R12 C



Zanquín recto
18 x 40 cm
7.1" x 15.7"

15 mm



Zanquín ML izda./dcha.
18 x 40 cm
7.1" x 15.7"

15 mm



Rodapié
9 x 40 cm
3.5" x 15.7"

15 mm

pasamanos. handrails



Pasamanos 12*
12,5 x 66,5 x 4 cm
4.9" x 26.2" x 1.6"

*medidas interiores.
inner dimensions.



Pasamanos 15*
15,5 x 66,5 x 4 cm
6.1" x 26.2" x 1.6"

*medidas interiores.
inner dimensions.

Albaroc in&out

boal]

- 1 Base · 33x33 cm - C-1 / R10
- 2 Base · 33x66,5 cm - C-3/ R12
- 3 Peldaño ML · 33x33x4 cm - C-3/ R12+C
- 4 Cartabón ML · 33x33x4 cm - C-3/ R12+C
- 5 Pasamanos 15 · 15,5x66,5x4 cm



Albaroc indoor

galena]

- 1 Base · 100x100 cm - C-1 / R10
- 2 Peldaño recto 120 · 33x120x3 cm - C-3 / R12
- 3 Tabica · 14,5x120 cm - C-1 / R10
- 4 Remate peldaño recto · 3x33 cm



Albaroc outdoor

hulla]

- 1 Base · 100x100 cm - C-3 / R12+C
- 2 Peldaño recto 120 · 33x120x3 cm - C-3 / R12+C

- 3 Tabica · 14,5x120 cm - C-1 / R10
- 4 Pasamanos · 15,5x66,5x4 cm



Albaroc outdoor+skimmer pool coping



hulla]

- 1 Base · 33x66,5 cm - C-1 / R10
- 2 Base · 33x66,5 cm - C-3 / R12+C

- 3 Peldaño recto 120 · 33x120x3 cm - C-3 / R12+C





STONE

Litos
in&out&in



ESPAÑOL / ENGLISH

Litos serie in&out&in

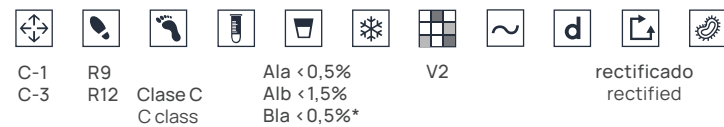

acabados. finishes



Ártico

Sabana

Siberia

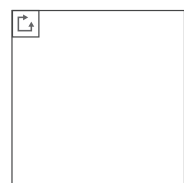

100x100 cm*
39.4" x 39.4"

10 mm
C-1 R9
C-3 R12 C Class

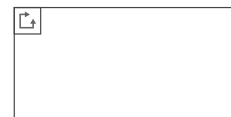

60x120 cm*
23.6" x 47.2"

9 mm
C-1 R9
C-3 R12 C Class



14,5x120 cm*
5.7" x 47.2"

9 mm
C-1 R9



33x66,5 cm
13.0" x 26.2"

10 mm
C-1 R9
C-3 R12 C Class

piezas piscinas. pool pieces



Borde desbordante
28 x 66,5 cm
11.0" x 26.2"

rectificado. rectified
C-3 R12 C

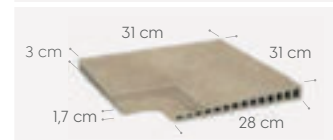

Ángulo desbordante
31 x 31 cm
12.2" x 12.2"

rectificado. rectified
C-3 R12 C



Rejilla
24,5x24,5 cm
9.6" x 9.6"

rectificado. rectified
C-3 R12 C



Ángulo rejilla izda./dcha.
33 x 33 cm
13.0" x 13.0"

rectificado. rectified
C-3 R12 C



Media caña 4
4,2 x 33 cm
1.7" x 13.0"



Arista 3
3,3 x 33 cm
1.3" x 13.0"

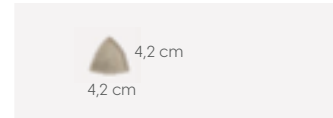

Uña media caña 4
4,2 x 4,2 cm
1.7" x 1.7"

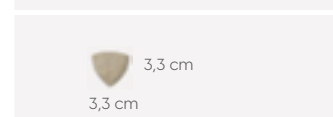

Uña arista 3
3,3 x 3,3 cm
1.3" x 1.3"

peldaños y rodapiés. steps&skirtings

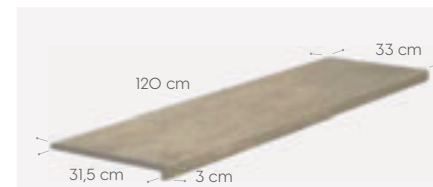

Peldaño recto 120
33 x 120 x 3 cm
13.0" x 47.2" x 1.2"

12 mm
rectificado. rectified
C-3 R12 C



Remate peldaño recto
3 x 33 cm
1.2" x 13.0"

7,5 mm



Rodapié
9 x 40 cm
3.6" x 15.7"

15 mm



Zanquín recto
18 x 40 cm
7.1" x 15.7"

15 mm

Litos indoor

siberia]

- 1 Base · 100x100 cm - C-1 / R9
- 2 Base · 60x120 cm - C-1 / R9

- 3 Peldaño recto 120 · 33x120x3 cm - C-3 / R12+C
- 4 Tabica · 14,5x120 cm - C-1 / R9

- 5 Remate peldaño recto · 3x33 cm



Litos outdoor+overflow pool coping

sabana]

- 1 Base · 60x120 cm - C-3 / R12+C
- 2 Borde desbordante · 28x66,5 cm - C-3 / R12+C
- 3 Rejilla · 24,5x24,5 cm - C-3 / R12+C
- 4 Áng. desbordante · 31x31 cm - C-3 / R12+C
- 5 Áng. rejilla izda/dcha. · 33x33 cm - C-3 / R12+C
- 6 Peldaño recto 120 · 33x120x3 cm - C-3 / R12+C
- 7 Tabica · 14,5x120 cm - C-1 / R9



Litos indoor+overflow pool coping

siberia]

- 1 Base · 60x120 cm - C-3 / R12+C
- 2 Borde desbordante · 28x66,5 cm - C-3 / R12+C
- 3 Rejilla · 24,5x24,5 cm - C-3 / R12+C
- 4 Áng. desbordante · 31x31 cm - C-3 / R12+C
- 5 Áng. rejilla izda/dcha. · 33x33 cm - C-3 / R12+C
- 6 Media caña 4 · 4,2x33 cm
- 7 Uña media caña 4 · 4,2x4,2 cm
- 8 Base · 33x66,5 cm - C-1 / R9



Borde desbordante
28 x 66,5 cm - 11.0" x 26.2"

C-3 R12 C

2



Ángulo desbordante
31 x 31 cm - 12.2" x 12.2"

C-3 R12 C

4



Rejilla
24,5 x 24,5 cm - 9.6" x 9.6"

C-3 R12 C

3



Áng. rejilla izda./dcha.
33 x 33 cm - 13.0" x 13.0"

C-3 R12 C

5



Media caña 4
4,2 x 33 cm - 1.7" x 13.0"

6



Uña media caña 4
4,2 x 4,2 cm - 1.7" x 1.7"

7





STONE

Manhattan

in&out



ESPAÑOL



ENGLISH



FRANÇAIS

Manhattan serie

in&out

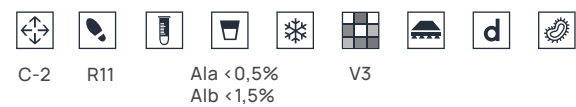

acabados. finishes



White

Grey

Mink

Red



24,5x24,5 cm
9.6" x 9.6"

± 9 mm
C-2 R11



12x24,5 cm
4.7" x 9.6"

± 9 mm
C-2 R11



5,75x24,5 cm*
2.3" x 9.6"

± 9 mm
C-2 R11

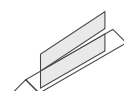

*El brick 5,75x24,5 se consigue de la plaqueta doble de precorte que se separa en obra.
The 5.75 x 24.5 brick is achieved from the double pre-cut plate that is separated on site.
Le brick 5,75 x 24,5 s'obtient par la double plaque de pré-découpage qui se sépare en construction.
Плитка 5,75 x 24,5 см получается из двойной пластины с предварительно сделанным пазом, которая разделяется при выполнении облицовочных работ.

Alb / Gres Extruido · Extruded Klinker · Grès Extrudé · Экструдированный Керамогранит
Ala / Gres Porcelánico Extruido · Extruded Porcelain Stoneware · Grès Porcelainé Extrudé · Экструдированный Керамогранит

peldaños y rodapiés. steps&skirtings

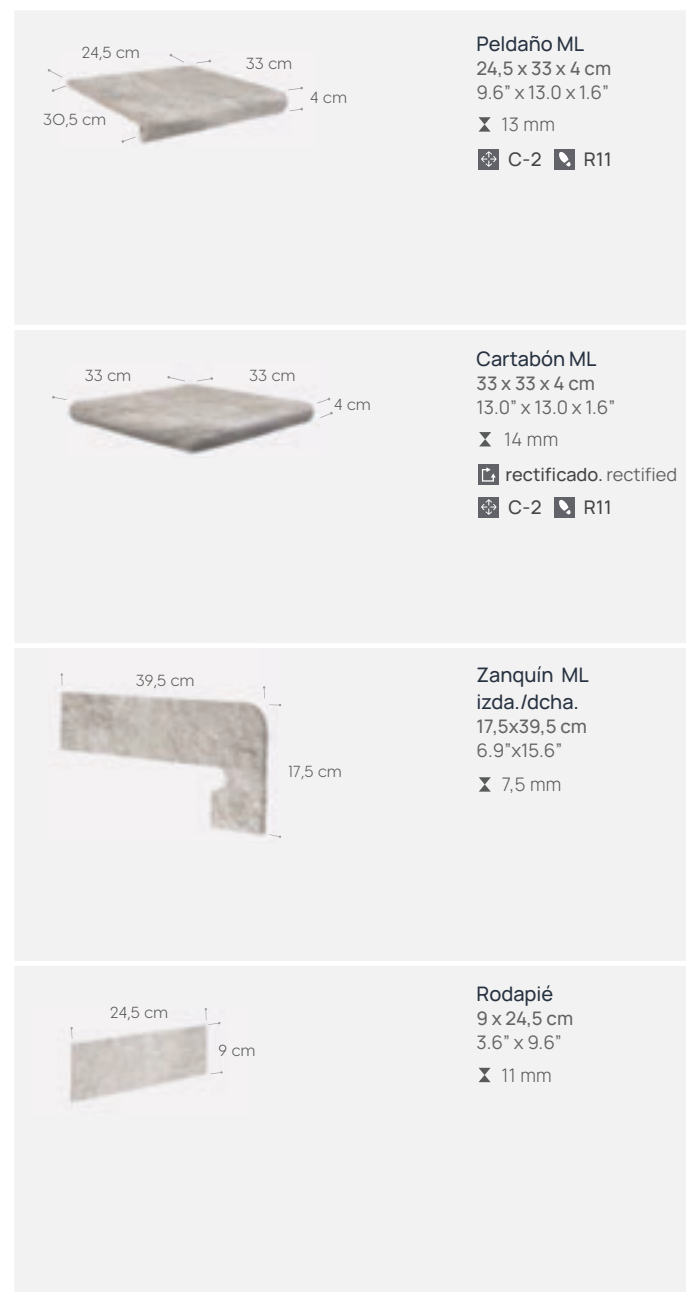

vierteaguas. window sills

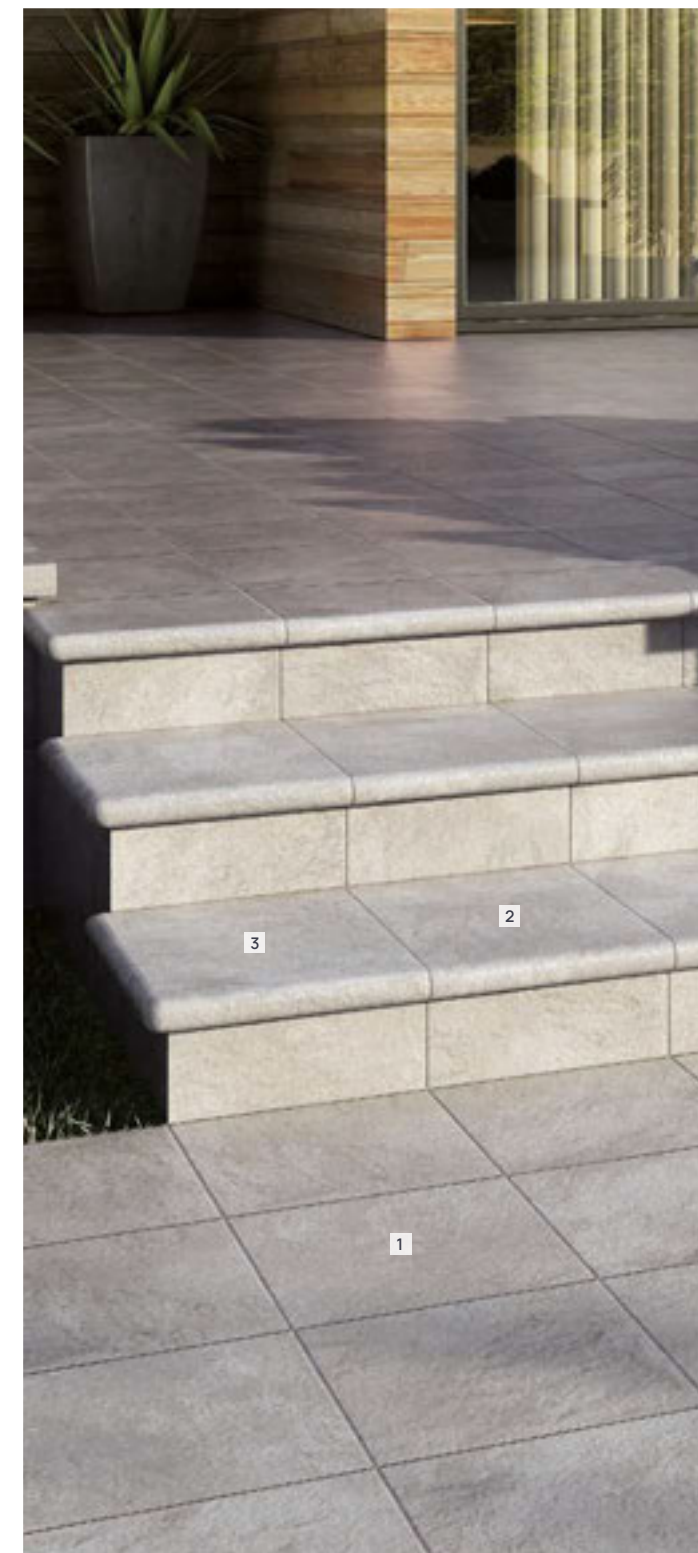

- 1 Base grey · 24,5x24,5 cm - C-2 / R11
2 Peldaño ML grey · 24,5x33x4 cm - C-2 / R11
3 Cartabón ML grey · 33x33x4 cm - C-2 / R11

Manhattan indoor

mink] **1** Base · 12x24,5 cm - C-2 / R11
2 Base · 5,75x24,5 cm - C-2 / R11

3 Peldaño ML · 24,5x33x4 cm - C-2 / R11
4 Cartabón ML · 33x33x4 cm - C-2 / R11



Manhattan outdoor

grey] **1** Base · 24,5x24,5 cm - C-2 / R11
2 Peldaño ML · 24,5x33x4 cm - C-2 / R11

3 Cartabón ML · 33x33x4 cm - C-2 / R11
4 Vierendeaguas · 15x24,5x4 cm



Manhattan outdoor



- grey]
- 1 Base · 24,5x24,5 cm - C-2 / R11
 - 2 Base · 5,75x24,5 cm - C-2 / R11

- red]
- 1 Base · 24,5x24,5 cm - C-2 / R11
 - 2 Base · 12x24,5 cm - C-2 / R11

- 3 Base · 5,75x24,5 cm - C-2 / R11
- 4 Vierteaguas · 15x24,5x4 cm





STONE

Vega
indoor



ESPAÑOL



ENGLISH



FRANÇAIS

Vega serie

indoor

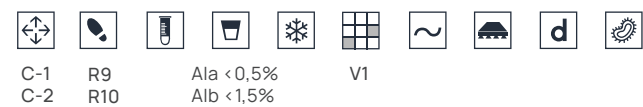

acabados. finishes



Visón

Gris

Rojo

Ocre



33x33 cm
13.0" x 13.0"

10 mm

C-1 R9

C-2 R10

peldaños y rodapiés. steps&skirtings

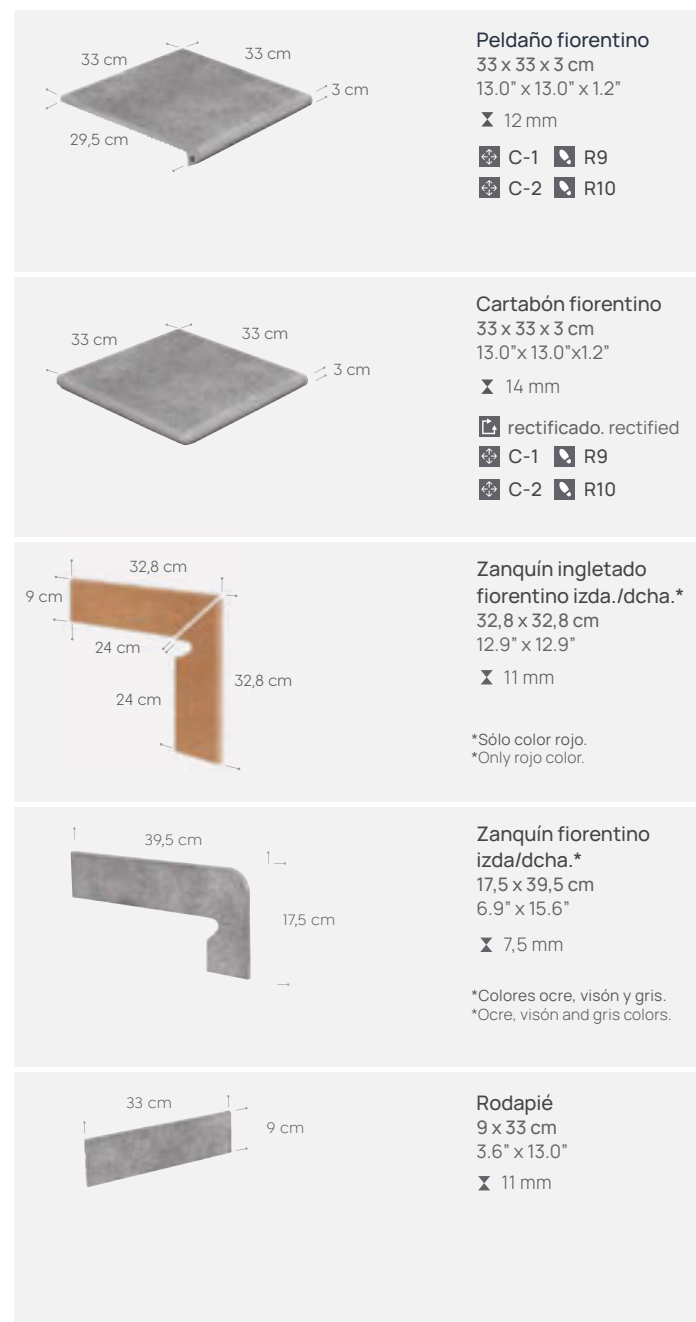

vierteaguas. window sills



1 Base ocre · 33x33 cm - C-1 / R9

2 Rodapié ocre · 9x33 cm



EARTH

Provenza

in&out&in



ESPAÑOL



ENGLISH

Provenza serie in&out&in

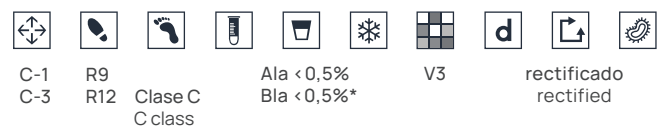

acabados. finishes



Bianco

Navona

Grigio

Nebbia



120x120 cm*
47.2" x 47.2"

9 mm
C-1 R9
C-3 R12 C Class



60x120 cm*
23.6" x 47.2"

9,2 mm
C-1 R9
C-3 R12 C Class



14,5x120 cm*
5.7" x 47.2"

9,2 mm
C-1 R9



33x33 cm
13.0" x 13.0"

10 mm



16,25x33 cm
6.4" x 13.0"

C-3 R12 C Class



16,25x16,25 cm
6.4" x 6.4"

piezas piscinas. pool pieces

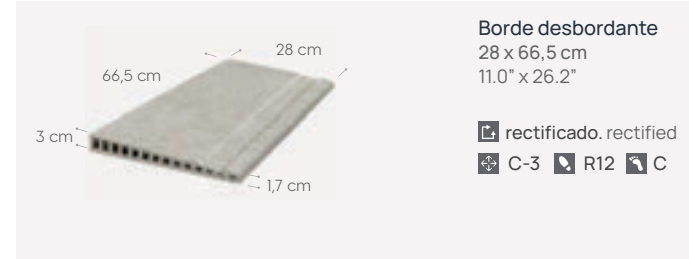
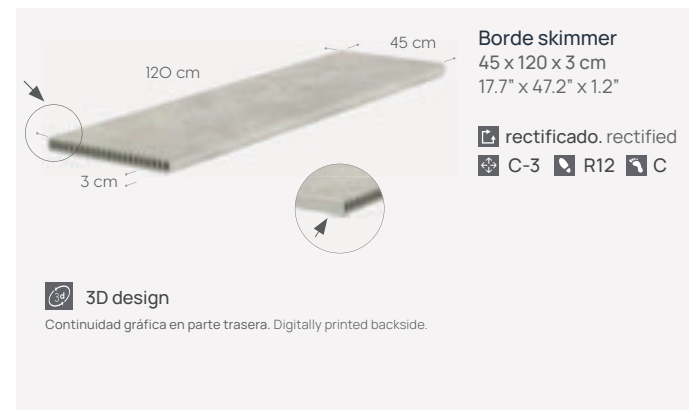

peldaños y rodapiés. steps&skirtings

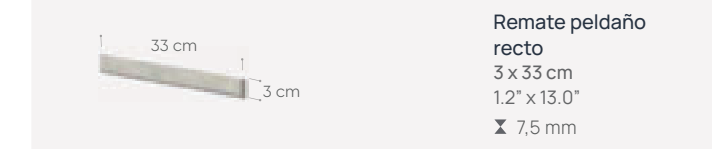
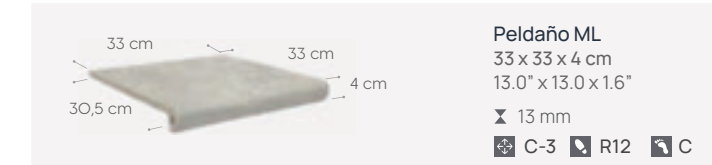

Provenza indoor | large format



nebbia]

1 Base · 120x120 cm - C-1 / R9

2 Peldaño recto 120 yoho oak · 33x120x3 cm - C-1 / R9

3 Remate peldaño recto yoho oak · 3x33 cm



Provenza indoor+skimmer pool coping | large format



bianco]

- 1 Base · 120x120 cm - C-3 / R12+C
- 2 Base · 60x120 cm - C-3 / R12+C

- 3 Borde skimmer · 45x120x3 cm - C-3 / R12+C
- 4 Peldaño recto 120 · 33x120x3 cm - C-3 / R12+C

- 5 Tabica · 14,5x120 cm - C-1 / R9



Provenza outdoor+overflow pool coping | large format



- grigio]
- 1 Base · 120x120 cm - C-3 / R12+C
 - 2 Borde desbordante · 28x66,5 cm - C-3 / R12+C
 - 3 Áng. desbordante · 31x31 cm - C-3 / R12+C
 - 4 Rejilla modular · 24,5x30 cm - C-3 / R12+C
 - 5 Áng. rejilla modular · 30x30 cm - C-3 / R12+C
 - 6 Peldaño recto 120 · 33x120x3 cm - C-3 / R12+C



EARTH

Provenza outdoor+skimmer pool coping | large format



navona]

- 1 Base · 120x120 cm - C-3 / R12+C
- 2 Base · 60x120 cm - C-1 / R9

- 3 Borde skimmer · 45x120x3 cm - C-3 / R12+C
- 4 Peldaño recto 120 · 33x120x3 cm - C-3 / R12+C

- 5 Tabica · 14,5x120 cm - C-1 / R9
- 6 Base · 60x120 cm - C-3 / R12+C



4

5

2

1

3

6

Provenza outdoor | small format



navona]

- 1 Base · 33x33 cm - C-3 / R12+C
- 2 Base · 16,25x33 cm - C-3 / R12+C

- 3 Base · 16,25x16,25 cm - C-3 / R12+C
- 4 Peldaño recto · 33x33 cm - C-3 / R12+C



Provenza outdoor+skimmer pool coping | small format

bianco]

- 1 Base · 33x33 cm - C-3 / R12+C
2 Base · 16,25x16,25 cm - C-3 / R12+C

- 3 Borde desbordante · 28x66,5 cm - C-3 / R12+C
4 Áng. desbordante · 31x31 cm - C-3 / R12+C

- 5 Rejilla modular · 24,5x30 cm - C-3 / R12+C
6 Áng. rejilla modular · 30x30 cm - C-3 / R12+C

- 7 Peldaño recto 120 · 33x120x3 cm - C-3/ R12+C



Provenza outdoor+skimmer pool coping | small format



grigio]

- 1 Base · 33x33 cm - C-3 / R12+C
- 2 Base · 16,25x16,25 cm - C-3 / R12+C
- 3 Borde skimmer · 45x120x3 cm - C-3 / R12+C
- 4 Peldaño recto · 33x33x3 cm - C-3 / R12+C
- 5 Tabica · 16,25x33 cm - C-3 / R12+C

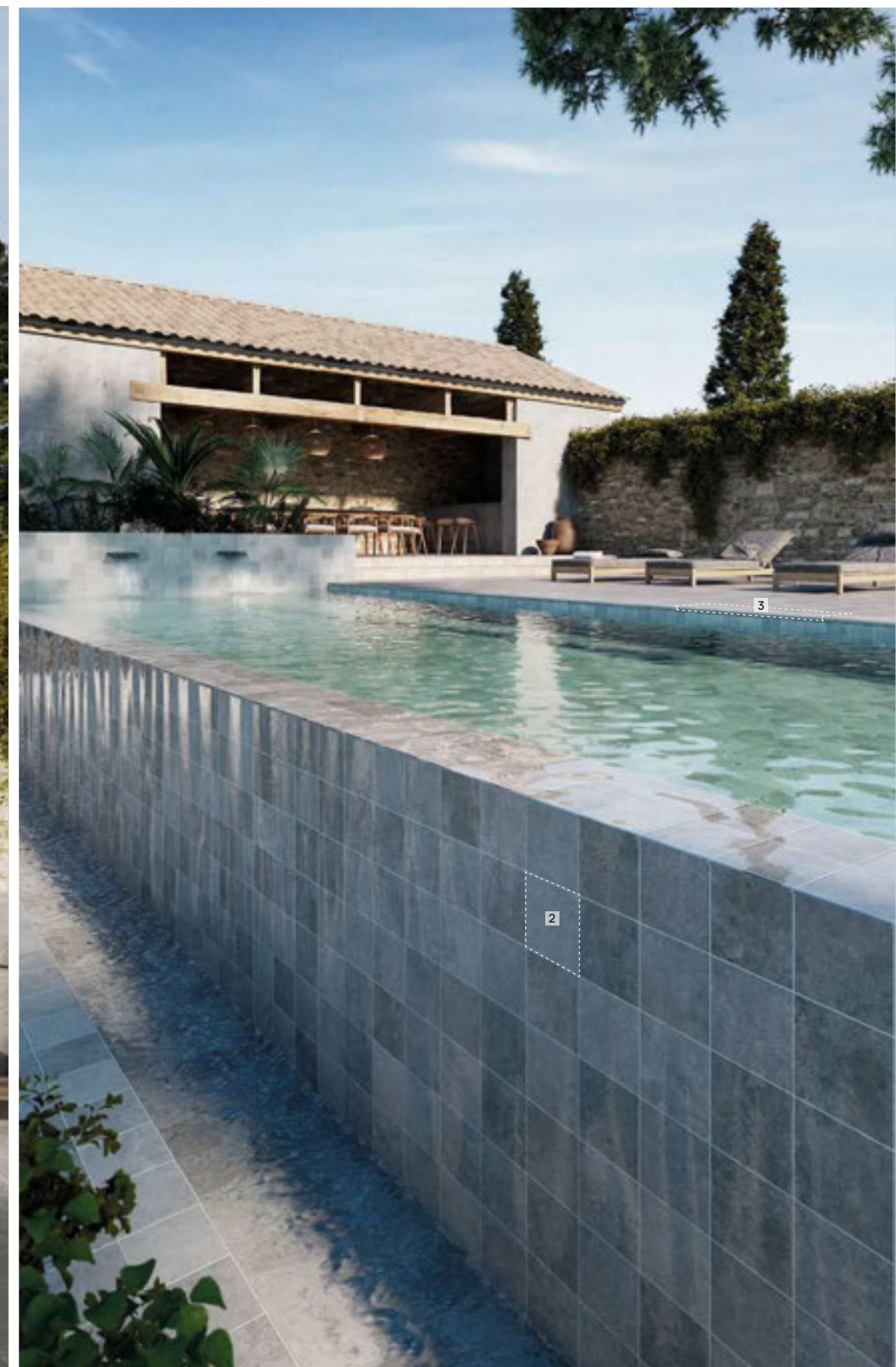



EARTH

Portland
outdoor



ESPAÑOL



ENGLISH

Portland serie outdoor



acabados. finishes

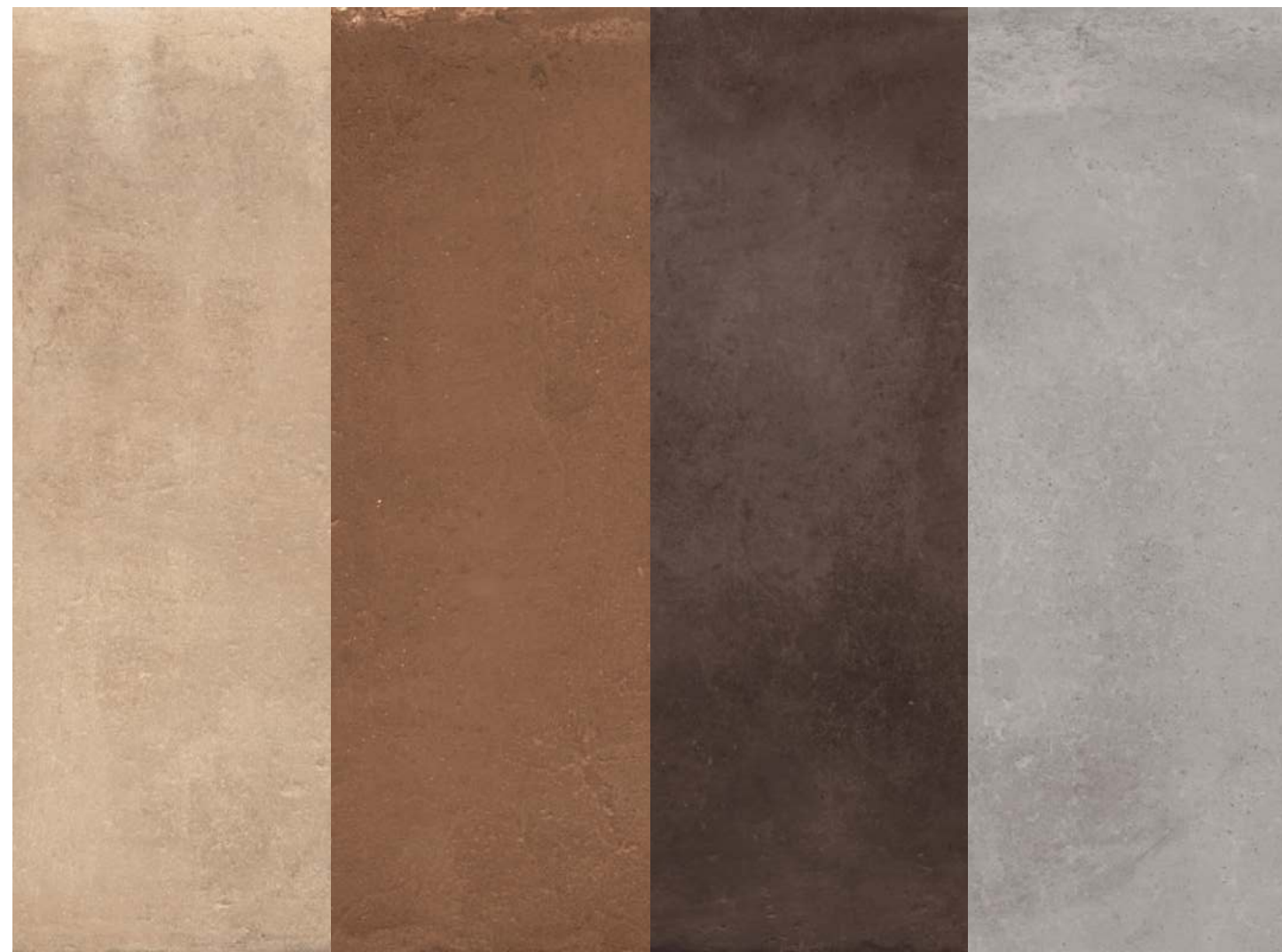

Dakar

Lava

Fondant

Grey



Black

peldaños. steps

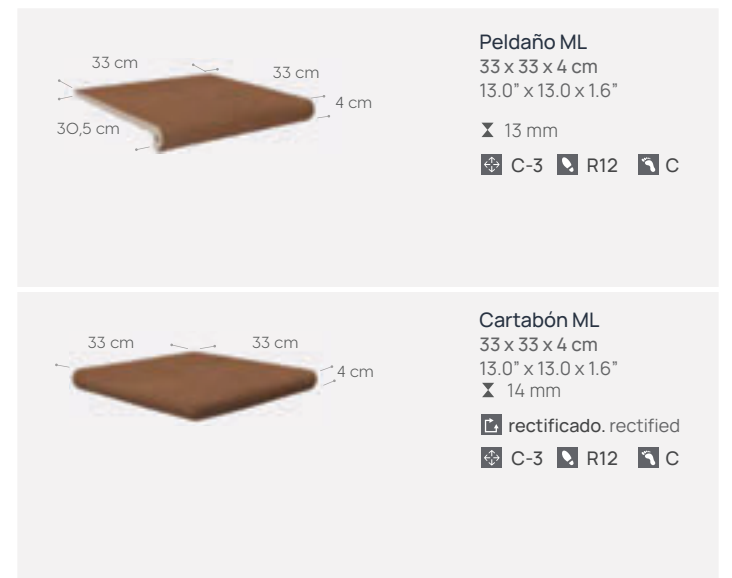

33x33 cm
13.0" x 13.0"

10 mm

C-3 R12

Portland outdoor

fondant]

- 1 Base · 33x33 cm - C-3 / R12
- 2 Peldaño ML · 33x33x4 cm - C-3/ R12

- 3 Cartabón ML · 33x33x4 cm - C-3/ R12



Portland outdoor



grey]

- 1 Base · 33x33 cm - C-3 / R12
- 2 Peldaño ML · 33x33x4 cm - C-3 / R12



Portland outdoor



black] 1 Base · 33x33 cm - C-3 / R12

2 Peldaño ML · 33x33x4 cm - C-3 / R12



Portland outdoor

dakar] **1** Base · 33x33 cm - C-3 / R12
2 Peldaño ML · 33x33x4 cm - C-3/ R12

3 Cartabón ML · 33x33x4 cm - C-3/ R12





EARTH

Alhamar

in&out



ESPAÑOL



ENGLISH



FRANÇAIS

Alhamar serie in&out

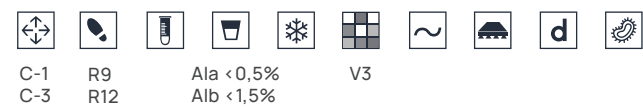

acabados. finishes

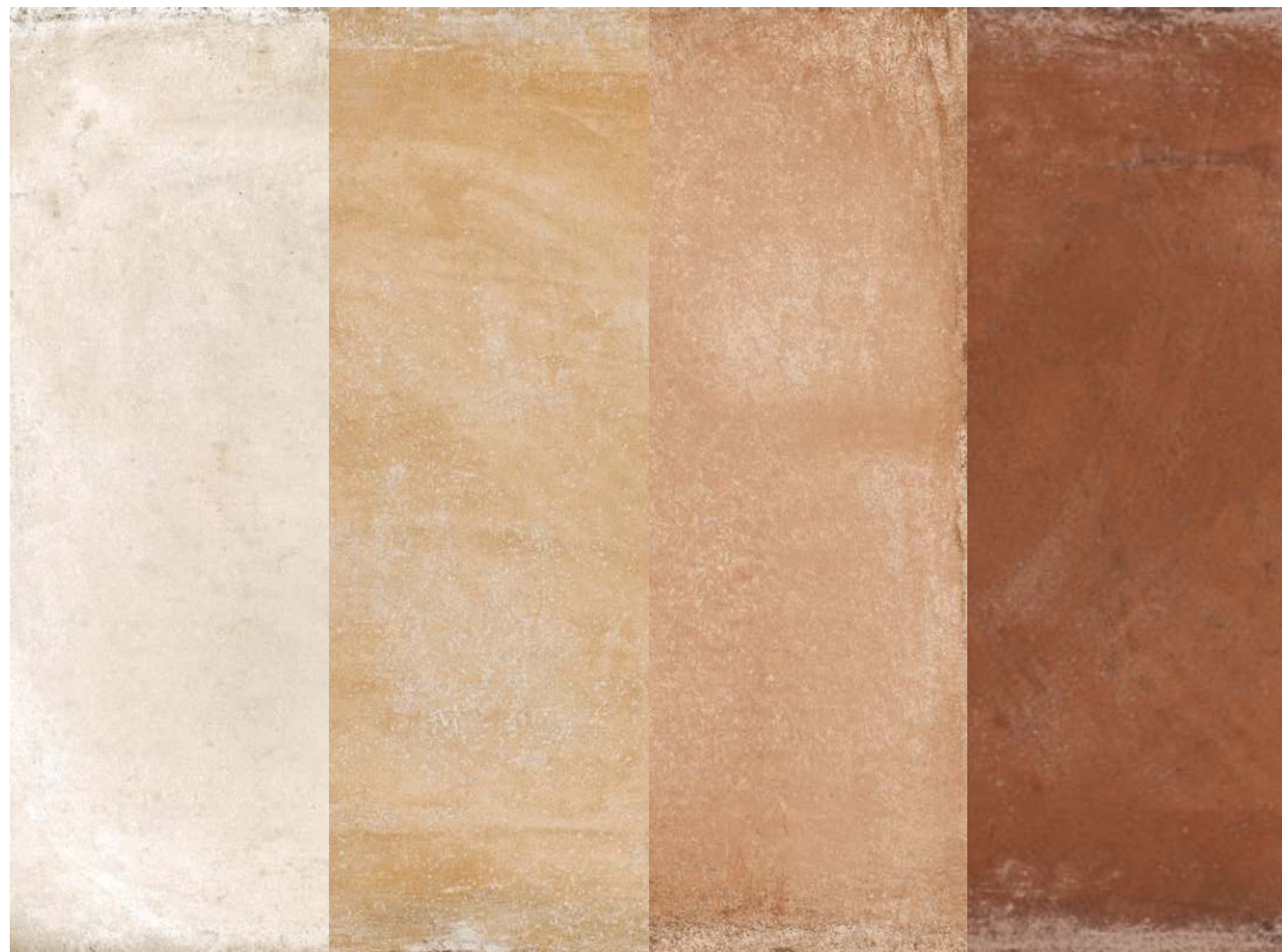

Blanco

Paja

Salmón

Rojo



33x33 cm
13.0" x 13.0"

10 mm
C-1 R9
C-3 R12



16,25x33 cm
6.4" x 13.0"

10 mm
C-3 R12



16,25x16,25 cm
6.4" x 6.4"

10 mm
C-3 R12

peldaños y rodapiés. steps&skirtings

Peldaño fiorentino
33 x 33 x 3 cm
13.0" x 13.0" x 1.2"
12 mm
C-3 R12

Cartabón fiorentino
33 x 33 x 3 cm
13.0" x 13.0" x 1.2"
14 mm
rectificado. rectified
C-3 R12

Zanquín ingletado fiorentino izda./dcha.*
32,8 x 32,8 cm
12.9" x 12.9"
11 mm

*colores paja, salmón y blanco.
paja, salmón and blanco colors

Zanquín fiorentino izda./dcha.*
17,5 x 39,5 cm
6.9" x 15.6"
7,5 mm

*color rojo.
rojo color.

Rodapié
9 x 33 cm
3.6" x 13.0"
11 mm

decorados. decors

Decorative
33 x 33 cm
13.0" x 13.0"
10 mm
C-3 R12

*1 set 4 piezas. 4 pieces pack.

Clay
33 x 33 cm
13.0" x 13.0"
10 mm
C-3 R12

*1 set 2 piezas. 2 pieces pack.

Tabica Clay
15 x 33 cm
5.9" x 13.0"
10 mm
C-3 R12

*1 set 2 piezas. 2 pieces pack.

vierteaguas. window sills

Vierteaguas
15 x 33 x 4 cm
5.9" x 13.0" x 1.6"
10 mm
C-3 R12

Alhamar in&out



paja]

- 1 Base · 33x33 cm - C-1 / R9
- 2 Base · 33x33 cm - C-3 / R12

- 3 Decorado clay · 33x33 cm - C-3 / R12
- 4 Peldaño fiorentino · 33x33x3 cm - C-3 / R12

- 5 Tabica · 16,25x33 cm - C-1 / R9
- 6 Vierendeaguas · 15x33x4 cm - C-3 / R12



Alhamar in&out

blanco]

- 1 Base · 33x33 cm - C-3 / R12
- 2 Peldaño fiorentino · 33x33x3 cm - C-3 / R12
- 3 Base · 16,25x33 cm - C-3 / R12



rojo]

- 1 Base · 33x33 cm - C-1 / R9
- 2 Decorativo rojo · 33x33cm - C-3 / R12
- 3 Base · 33x33 cm - C-3 / R12
- 4 Vierteaguas · 15x33x4 cm





METAL

Metálica

indoor



ESPAÑOL



ENGLISH



FRANÇAIS

Metálica serie indoor

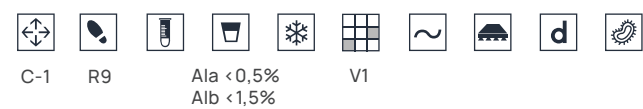

acabados. finishes



Vulcano

Cherry

Basalt

Purple



33x33 cm
13.0" x 13.0"

⌘ 10 mm

⊞ C-1 ⊞ R9

peldaños y rodapiés. steps&skirtings

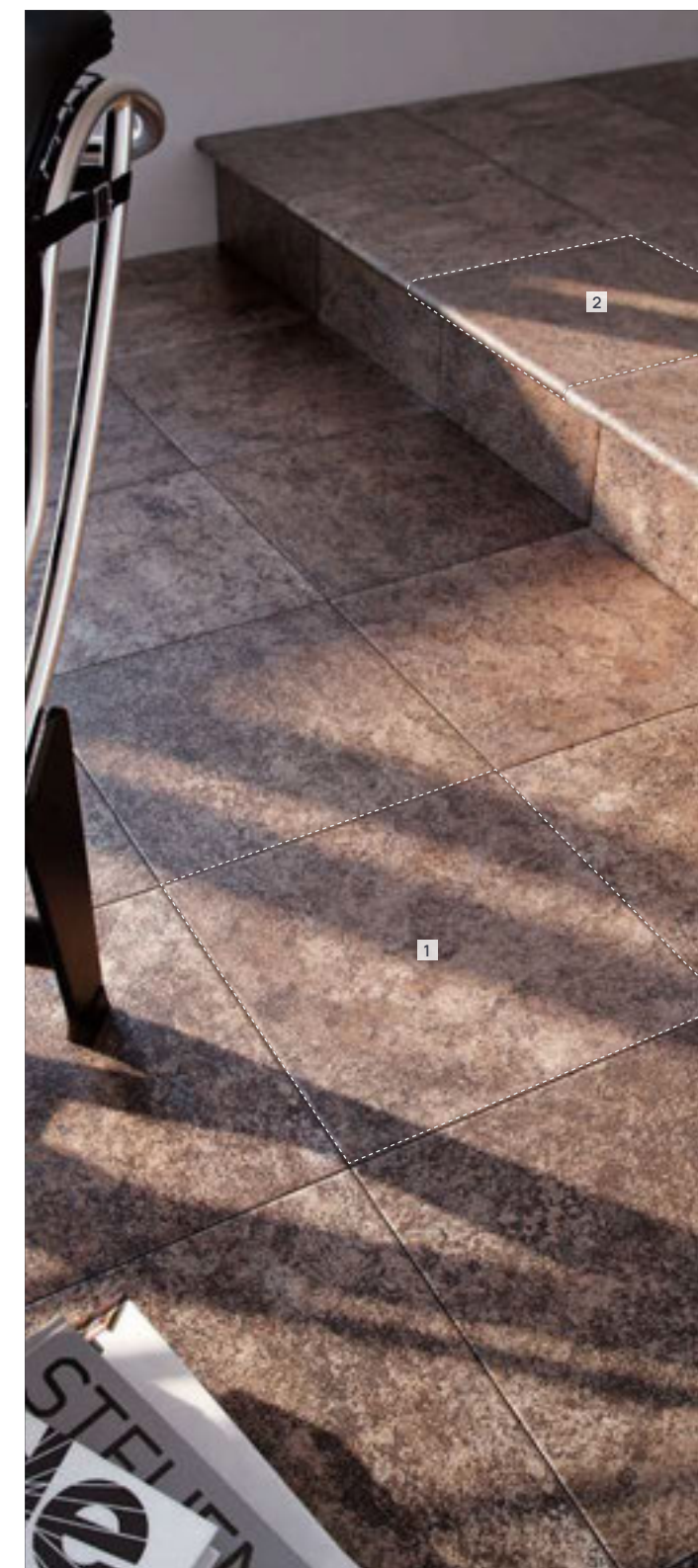
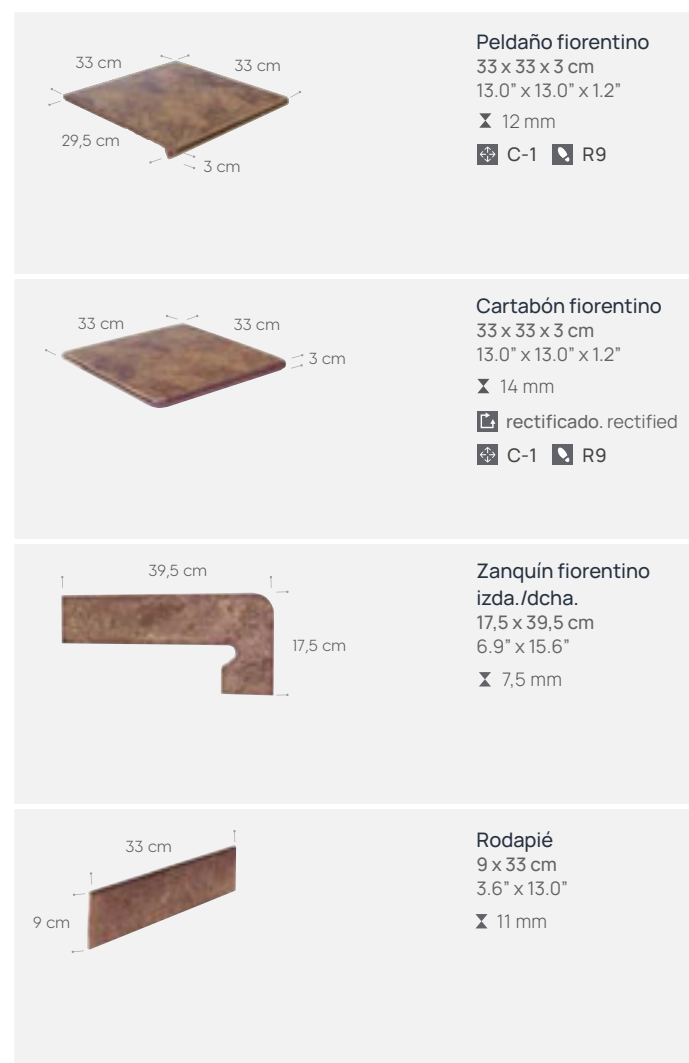

1 Base vulcano · 33x33 cm - C-1 / R9

2 Peldaño fiorentino vulcano · 33x33x3 cm - C-1 / R9

Área técnica]

Technical area. Zone technique.

Техническая область.



Exagres se caracteriza por ofrecer una amplia gama de producto conformado mediante extrusión, con elevadas características técnicas, ideales tanto para el interior como el exterior de la vivienda, además de poderse dirigir a espacios públicos y privados.

Con el proceso de extrusión se consiguen piezas con determinadas geometrías y secciones complejas imposibles de alcanzar mediante el prensado, dando así soluciones completas para recubrimientos integrales y homogéneos con un mismo material cerámico.

Todo esto unido con la tecnología de impresión digital, que permite decorar con cualquier diseño la pieza cerámica por completo, desde los bajos relieves hasta los diferentes planos que ofrecen nuestras piezas, hace que Exagres pueda ofrecer un producto único y de calidad superior tanto técnica como estéticamente.

El objetivo principal de Exagres son los clientes, por ese motivo estamos al corriente de las últimas tendencias para poder ofrecer productos innovadores como soluciones en peldaños de gran formato y piscinas.



Exagres is characterised by the wide range of products, shaped through extrusion, that it has on offer. These products have important technical characteristics, ideal for both inside and outside the home, as well as being suitable for both public and private spaces.

Through the extrusion process, pieces are obtained with certain geometries and complex sections that are impossible to achieve through compacting, thus providing complete solutions for integral and standardised cladding with the same ceramic material.

All of this, together with the digital printing technology which permits decoration on the entire ceramic piece with any design, from low relief to the various images offered by our pieces, means that Exagres can offer a unique product with superior quality both technically and aesthetically.

The principal objective of Exagres is our customers, therefore we stay up to date with the latest trends in order to be able to offer innovative products as solutions for large scale stairs and swimming pools.

La particularité d'Exagres est d'offrir une large gamme de produits mis en forme par extrusion, aux grandes caractéristiques techniques, idéales aussi bien pour l'intérieur que pour l'extérieur du logement, en plus de pouvoir s'adresser à des espaces publics et privés.

Grâce au procédé d'extrusion, il est possible d'obtenir des pièces aux géométries spécifiques et des sections complexes impossibles à atteindre par le pressage, apportant ainsi des solutions complètes pour des revêtements intégraux et homogènes avec un même matériau céramique.

Tout cela associé à la technologie d'impression numérique, qui permet de décorer entièrement avec n'importe quel design la pièce céramique, des bas-reliefs aux différents plans qu'offrent nos pièces, permet à Exagres d'offrir un produit unique et de qualité supérieure aussi bien technique qu'esthétique.

L'objectif principal d'Exagres sont les clients, pour cette raison nous suivons les dernières tendances afin de pouvoir offrir des produits innovants tels que des solutions pour le marché des piscines et des marches de grand format.

Компания Exagres предлагает широкий спектр продукции, изготовленной путем экструзии, с высокими техническими характеристиками, идеально подходящей как для внутренней, так и наружной отделки домов, в дополнение к тому, что она может использоваться для частных и общественных пространств.

С помощью процесса экструзии мы можем изготавливать изделия с заданными размерами и сложными формами, которые невозможно достичь путем прессования, что позволяет нам предлагать универсальные решения для комплексной и однородной отделки с одним и тем же видом керамического материала.

Все это в сочетании с технологией цифровой печати, которая позволяет наносить любые изображения на керамическую плитку, начиная от рельефных текстур и заканчивая различными цветовыми решениями выпускаемых нами изделий, позволяет компании Exagres предлагать уникальную высококачественную продукцию как с технической, так и эстетической точки зрения.

Основной задачей компании Exagres является удовлетворение потребностей клиентов, поэтому мы всегда следим за последними тенденциями с тем, чтобы предлагать инновационную продукцию как крупноформатные ступени и изделия для бассейнов.

Soluciones in&out&in

Exagres ofrece soluciones globales. El gres extruido porcelánico de Exagres es un producto completo que ofrece una solución total para recubrir el 100% de los proyectos residenciales y recreativos.

Exagres offers global solutions. Exagres extruded porcelain stoneware is a complete product that offers a total solution to cover 100% of residential and recreational projects.

Exagres offre des solutions globales. Le grès cérame extrudé Exagres est un produit complet qui offre une solution totale pour couvrir 100% des projets résidentiels et récréatifs.

Exagres предлагает глобальные решения. Экструдированный керамогранит Exagres - это комплексный продукт, который предлагает полное решение для покрытия 100% жилых и рекреационных объектов.



Opciones de colocación multiformato.

Multi-format placement options. Options de placement multi-format.
Варианты размещения в разных форматах.



MANHATTAN

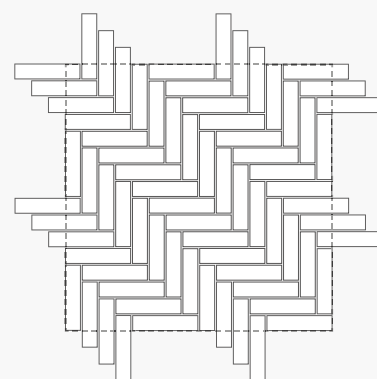

1 m²

5,75 x 24,5 cm | 76 uds/m²



ARDENAS

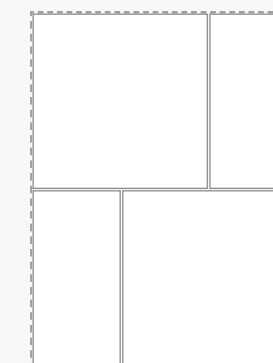

3,24 m²

120 x 120 cm		2 piezas. pieces
60 x 120 cm		2 piezas. pieces



ALBAROC

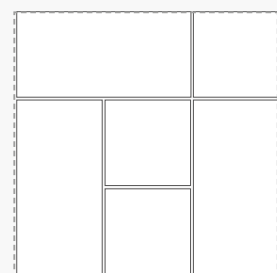

1 m²

33 x 33 cm		3 piezas. pieces
33 x 66,5 cm		3 piezas. pieces



ARDENAS

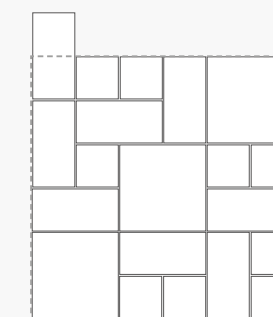

1 m²

33 x 33 cm		3 piezas. pieces
16,25 x 33 cm		7 piezas. pieces
16,25 x 16,25 cm		9 piezas. pieces

Soluciones técnicas: Escaleras.

Technical solutions: Steps. Solutions techniques: Marches. Технические решения: Ступени.

Escaleras peldaños rectos. Stairs square tread.

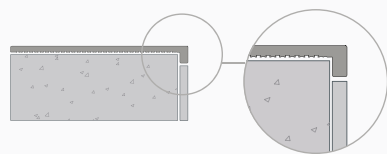

Peldaños rectos Square step treads

Peldaño recto 120.
33 x 120 x 3 cm - 13.0" x 47.2" x 1.2"
X 12 mm rectificado. rectified



IMPERIAL

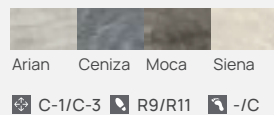

NUBIA

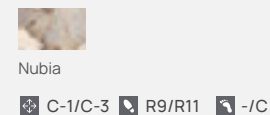

MARBLES

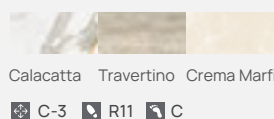

LIZANA

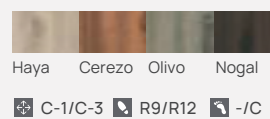

YOHO

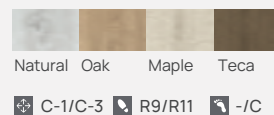

COSMOS

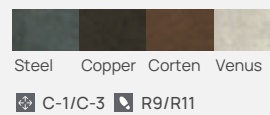

ÓPERA

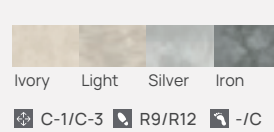

BEDFORD

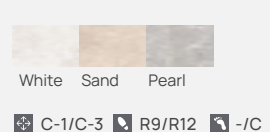

ARDENAS

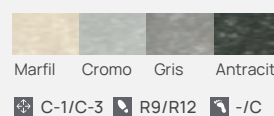

ALBAROC

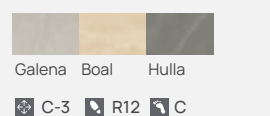

LITOS

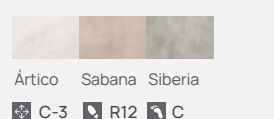

PROVENZA

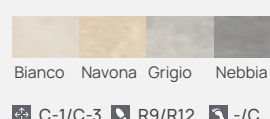

Peldaño recto 60.
33 x 60 x 3 cm - 13.0" x 23.6" x 1.2"
X 12 mm rectificado. rectified



MARBLES

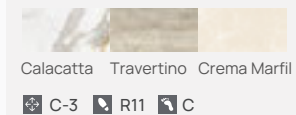

Peldaño recto.
33 x 33 x 3 cm - 13.0" x 13.0" x 1.2"
X 12 mm



MEDITERRÁNEO

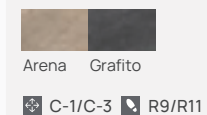

BEDFORD

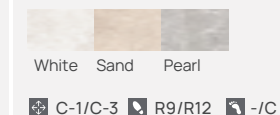

PROVENZA

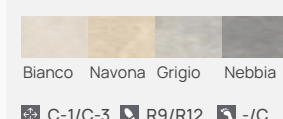

Soluciones técnicas: Escaleras.

Technical solutions: Steps. Solutions techniques: Marches. Технические решения: Ступени.

Remate peldaño recto Square step tread side cover

Remate peldaño recto.
3 x 33 cm - 1.2" x 13.0"

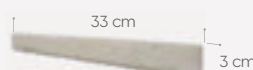

IMPERIAL

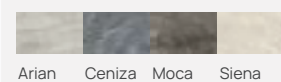

LIZANA

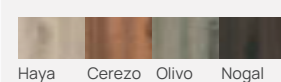

COSMOS

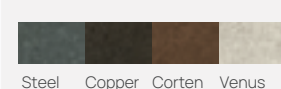

BEDFORD

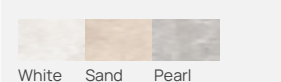

ALBAROC



PROVENZA

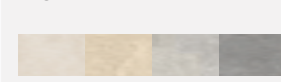

MARBLES

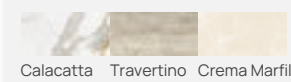

YOHO

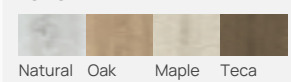

ÓPERA

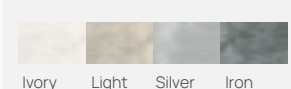

ARDENAS

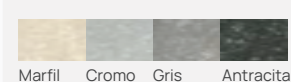

LITOS

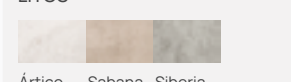

Zanquines Skirtings

Zanquín recto izda./dcha.
17,5 x 42,3 cm - 6.9" x 16.7"
x 7,5 mm



YOHO



ÓPERA

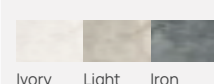

MEDITERRÁNEO

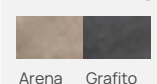

Zanquín ingletado recto
32,8 x 32,8 cm - 12.9" x 12.9"
x 11 mm

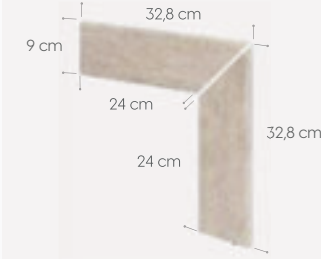

Zanquín ingletado recto izda./dcha.
59,6 x 59,6 cm - 23.5" x 23.5"
x 11 mm



IMPERIAL

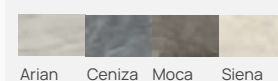

LIZANA

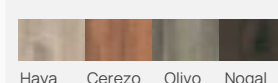

YOHO

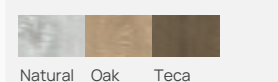

COSMOS

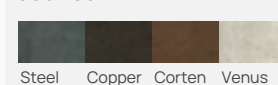

ÓPERA



BEDFORD

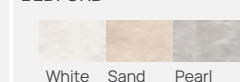

ARDENAS

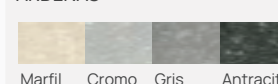

PROVENZA

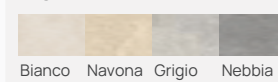

Zanquín recto izda./dcha.
18 x 40 cm - 13.0" x 47.2"

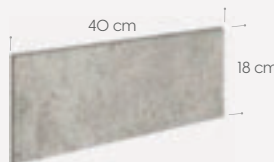

MARBLES

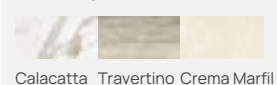

LITOS

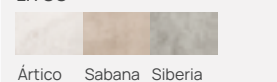

ALBAROC

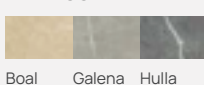

Soluciones técnicas: Escaleras.

Technical solutions: Steps. Solutions techniques: Marches. Технические решения: Ступени.

Escaleras peldaños ML. Stairs ML tread.

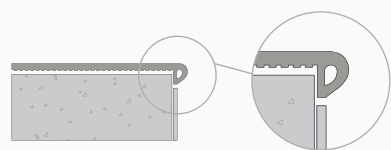

Peldaños ML ML Steps

Peldaño ML 150
33 x 150 x 4 cm - 13.0" x 59.1" x 1.6"
± 13 mm rectificado. rectified



LIZANA
Haya Cerezo Olivo Nogal
C-1/C-3 R9/R12 -/C

Peldaño ML 120
33 x 120 x 4 cm - 13.0" x 47.2" x 1.2"
± 13 mm rectificado. rectified

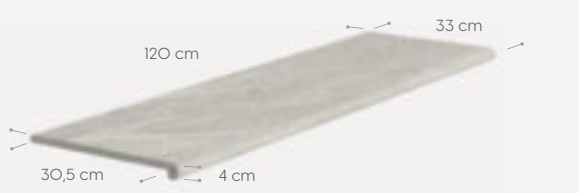

IMPERIAL
Arian Ceniza Moca Siena
C-1 R9

VENATTO
Perla
C-1/C-3 R9/R11 -/C

Zanquines Skirtings

Zanquín ingletado ML izda./dcha.
59,6 x 59,6 cm - 23.5" x 23.5"
± 11 mm



IMPERIAL
Arian Ceniza Moca Siena

VENATTO
Perla

LIZANA
Haya Cerezo Olivo Nogal

ARDENAS
Marfil Cromo Gris Antracita

PROVENZA
Bianco Navona Grigio Nebbia

Peldaño ML
33 x 33 x 4 cm - 13.0" x 13.0" x 1.6"
24,5 x 33 x 4 - 9.6" x 13.0" x 1.6" *
± 13 mm



Cartabón ML
33 x 33 x 4 cm - 13.0" x 13.0" x 1.6"
± 14 mm rectificado. rectified

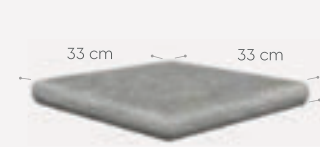

ARDENAS
Marfil Cromo Gris Antracita
C-3 R12 C

MANHATTAN*
White Grey Mink Red
C-2 R11

ALBAROC
Boal Galena Hulla
C-3 R12

PORTLAND
Dakar Lava Fondant Grey Black
C-3 R12 C

PROVENZA
Bianco Navona Grigio Nebbia
C-1/C-3 R9/R12 -/C

Remate peldaño ML ML step tread side cover

Remate ML izda./dcha.
4 x 33 cm - 1.6" x 13.0"



IMPERIAL
Arian Ceniza Moca Siena

LIZANA
Haya Cerezo Olivo Nogal

VENATTO
Perla

Zanquín ML izda./dcha.
18 x 40 cm - 7.1" x 15.7"
± 15 mm

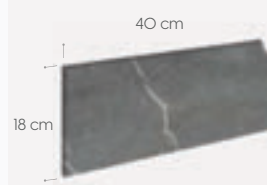

ALBAROC
Boal Galena Hulla

Zanquín ML izda./dcha.
17,5 x 39,5 cm - 6.9" x 15.5"
± 7,5 mm



MANHATTAN
White Grey Mink Red

Soluciones técnicas: Escaleras.

Technical solutions: Steps. Solutions techniques: Marches. Технические решения: Ступени.

Escaleras peldaños fiorentino.

Stairs fiorentino tread.

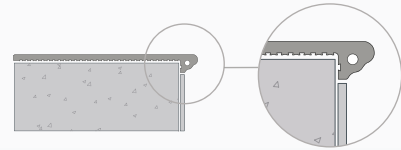

Peldaños fiorentino

Fiorentino steps

Peldaño fiorentino 120
33 x 120 x 3 cm - 13.0" x 47.2" x 1.2"
12 mm rectificado. rectified

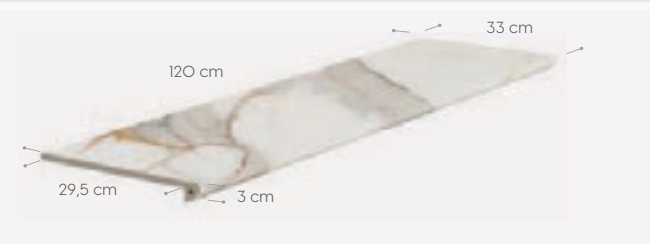

MARBLES
Calacatta Travertino Crema Marfil
C-1 R9

Peldaño fiorentino
33 x 33 x 3 cm - 13.0" x 13.0" x 1.2"
12 mm

Cartabón fiorentino
33 x 33 x 3 cm - 13.0" x 13.0" x 1.2"
14 mm rectificado. rectified



MEDITERRÁNEO
Arena Grafito
C-1/C-2 R9/R11

VEGA
Visón Gris Rojo Ocre
C-1/C-2 R9/R10

ALHAMAR
Blanco Paja Salmón Rojo
C-3 R12

METÁLICA
Vulcano Cherry Basalt Purple
C-1 R9

Zanquines

Skirtings

Zanquín fiorentino izda/dcha.
32,8 x 32,8 cm - 12.9" x 12.9"
11 mm



MEDITERRÁNEO Arena
VEGA Rojo
ALHAMAR Paja

Zanquín fiorentino izda/dcha.
17,5 x 39,5 cm - 6.9" x 15.5"
11 mm



MEDITERRÁNEO Grafito
VEGA Ocre Visón Gris
ALHAMAR Blanco Salmón Rojo
METÁLICA Purple Vulcano Cherry Basalt

Zanquín fiorentino izda/dcha.
18 x 40 cm - 7.1" x 15.7"
15 mm



MARBLES
Calacatta Travertino Crema Marfil

Remate peldaño fiorentino

Fiorentino step tread side cover

Remate peldaño fiorentino izda./dcha.
3 x 33 cm - 1.21" x 13.0"



MARBLES
Calacatta Travertino Crema Marfil

Soluciones técnicas: Muros.

Technical solutions: Walls. Solutions techniques: Murs. Технические решения: Стены.

Vierteaguas Window sills

- Forma rectangular con borde lateral redondeado provisto de goterón. Superficie inferior ranurada en cola de milano para optimizar el agarre al soporte.
- Rectangle shape with lateral rounded edge provided with big drop. Back tile in dove tail profile to improve the hold to the stab.
- Format rectangulaire, le bord latérale arrondi avec dispositif anti-goutte. La surface inférieure fendue en queue d'aronde pour optimiser l'adhérence de l'appui.
- Элементы имеют прямоугольную форму с одним закругленным краем для облегчения дренажа. Обратная сторона элементов выполнена в форме сечения "ласточкин хвост" для надежной фиксации элемента.

Aplicaciones y colocación • applications and installation • applications et pose • применение и монтаж

- Vierteaguas en ventanas, marquesinas, voladizos, repisas, remate superior de muros medianeros, perimetrales y cercas.
- Window Sills in windows, porches, projecting, brackets, top finishing for diving walls, perimeter walls and fences.
- Appuie pour les fenêtres, marquises, rebords, finition supérieur de murs mitoyens, des clôtures, etc.
- Данная плита укладывается как подоконник, так же подходит для отделки террас, изгородей, а так же как наружная облицовка.



Vierteaguas
15 x 24,5 x 4 cm - 5.9" x 9.6" x 1.6" 10 mm
12 x 33 x 3 cm - 3.6" x 13.0" x 1.2" 12 mm
15 x 33 x 4 cm - 5.9" x 13.0" x 1.6" 10 mm



MEDITERRÁNEO 12 x 33 x 3 cm

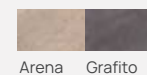

MANHATTAN 15 x 24,5 x 4 cm

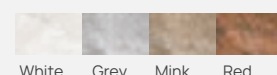

VEGA 12 x 33 x 3 cm

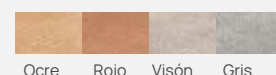

ALHAMAR 15 x 33 x 4 cm

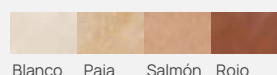

Pasamanos Handrails

- Forma rectangular con bordes laterales redondeados provistos de goterón, la parte superior dispone de una ligera curvatura que facilita el drenaje. Superficie interior ranurada en cola de milano para optimizar el agarre al soporte.
- Rectangle shape with lateral rounded edges provided with big drop, the top side has a slight curvature (bend) to ease the drainage. Back tile in dove tail profile to improve the hold to the stab.
- Format rectangulaire, les bords latérales arrondis avec dispositif anti-goutte, la partie supérieure dispose d'une très légère courbature pour faciliter le drainage. Superficie intérieur rainurer pour faciliter la pose sur tous types de support.
- Элементы имеют прямоугольную форму с закругленными краями по углам, верхняя сторона имеет небольшой изгиб для облегчения дренажа. Обратная сторона элементов выполнена в форме сечения "ласточкин хвост" для надежной фиксации элемента.

Aplicaciones y colocación • applications and installation • applications et pose • применение и монтаж

- Cubremuros, antepechos de terrazas, azoteas, tendederos, escaleras, pretilos y coronación de cercas y muros divisorios.
- Top-wall finishing, terrace parapets, flat roofs, drying places, stairs, handrails and tops for fences and dividing walls.
- Main courante, couvre-murs, finition de murs verticales, etc.
- Используется в качестве поручней и перил лестниц. Может применяться для финишной отделки парапетов террас, плоских крыш, верхнего облицовочного элемента стенок, пергородок и т.д.



Pasamanos
12,5 x 66,5 x 4 cm - 4.9" x 26.2" x 1.6"
15,5 x 66,5 x 4 cm - 6.1" x 26.2" x 1.6"



medidas interiores. inner measures*

MEDITERRÁNEO

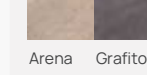

ALBAROC

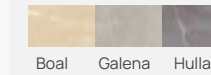

Piscinas residenciales]

Residential pools. Piscines résidentielles.
Жилые бассейны.



Sistema de coronación skimmer Skimmer coping system

Los bordes de la piscina no sólo aportan su valor estético al conjunto de la misma sino que también resultan sumamente importantes respecto a parámetros de seguridad y comodidad.

El sistema skimmer es un sistema de coronación estandarizado en el que el nivel del agua se sitúa a unos 10-15 centímetros por debajo de los bordes..

Las piscinas tradicionales son funcionales y requieren un mantenimiento sencillo.

Los skimmers son, simplemente, las aberturas situadas debajo del borde y sirven para filtrar el agua. Gracias a las diferentes piezas especiales que componen las colecciones que disponen de la coronación skimmer (Imperial, Lizana, Venatto, Ópera, Yoho, Milán, Marbles, Petra, Natura..) es posible lograr una continuidad estética entre el interior y el exterior de las diferentes estancias que puede tener cualquier proyecto, ya sea de carácter residencial o contract.

The edges of the pool not only add aesthetic value to the pool, but are also extremely important in terms of safety and comfort parameters.

The skimmer is a standardised coping system that is located about 10-15 cm below the pool edge. Traditional pools are functional and only require basic maintenance. Skimmers are openings located below the edge of the pool that filter the water. Our collections featuring skimmer copings (Imperial, Lizana, Venatto, Ópera, Yoho, Milán, Marbles, Petra, Natura..) feature a variety of special pieces that allow you to achieve perfect aesthetic continuity between the interior and exterior spaces that make up your project, whether it's a residential or commercial project.

Les abords de la piscine n'ajoutent pas seulement une valeur esthétique à la piscine, mais sont également extrêmement importants en termes de paramètres de sécurité et de confort.

Le système de skimmer est un système de margelle standardisé dans lequel le niveau d'eau se situe à environ 10-15 centimètres sous les bords. Les piscines traditionnelles sont fonctionnelles et nécessitent un entretien simple.

Les skimmers sont simplement les ouvertures sous le bord et servent à filtrer l'eau. Grâce aux différentes pièces spéciales qui composent les collections à margelles (Imperial, Lizana, Venatto, Ópera, Yoho, Milán, Marbles, Petra, Natura..) il est possible d'obtenir une continuité esthétique entre l'intérieur et l'extérieur des différentes pièces de tout projet, qu'il soit résidentiel ou contractuel.

Окружение бассейна не только придает ему эстетическую ценность, но и имеет огромное значение с точки зрения параметров безопасности и комфорта.

Система скиммеров - это стандартизированная система копания, в которой уровень воды находится примерно на 10-15 сантиметров ниже краев. Традиционные бассейны функциональны и требуют простого ухода. Скиммеры - это просто отверстия под бортиком, которые служат для фильтрации воды. Благодаря различным специальным элементам, составляющим коллекции со скиммерным покрытием (Imperial, Lizana, Venatto, Ópera, Yoho, Milán, Marbles, Petra, Natura..) можно достичь эстетической непрерывности между интерьером и экстерьером различных помещений любого проекта, как жилого, так и контрактного.



Piscinas residenciales. Sistema de coronación skimmer.

Residential pools: skimmer coping system. Piscines résidentielles: skimmer.

Технические решения: Жилые бассейны

Piezas coronación piscina] Pool coping pieces

Borde skimmer
45 x 120 x 3 cm - 17.7" x 47.2" x 1.2"
rectificado.rectified



BEDFORD
White Sand Pearl
C-3 R12 C

PROVENZA
Bianco Navona Grigio Nebbia
C-3 R12 C

Borde skimmer
45 x 75 x 3 cm - 17.7" x 29.5" x 1.2"
rectificado.rectified

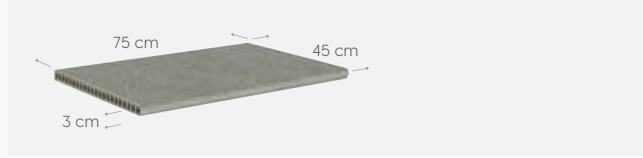

IMPERIAL
Arian Ceniza Moca Siena
C-3 R11 C

VENATTO
Perla
C-3 R11 C

YOHO
Natural Oak Maple Teca
C-3 R11 C

ÓPERA
Ivory Light Silver Iron
C-3 R12 C

ARDENAS
Marfil Cromo Gris Antracita
C-3 R12 C

Peldaño recto 120 / 60
33 x 120 x 3 cm - 13.0" x 47.2" x 1.2"
33 x 60 x 3 cm - 13.0" x 23.6" x 1.2" *
12 mm rectificado.rectified



*disponible sólo en serie Marbles.
Available only in the Marbles series.

IMPERIAL
Arian Ceniza Moca Siena
C-3 R11 C

NUBIA
Nubia
C-3 R11 C

MARBLES
Calacatta Travertino Crema Marfil
C-3 R11 C

LIZANA
Haya Cerezo Olivo Nogal
C-3 R12 C

YOHO
Natural Oak Maple Teca
C-3 R11 C

COSMOS
Steel Copper Corten Venus
C-3 R11 C

ÓPERA
Ivory Light Silver Iron
C-3 R12 C

BEDFORD
White Sand Pearl
C-1/C-3 R9/R12 -/C

ARDENAS
Marfil Cromo Gris Antracita
C-3 R12 C

ALBAROC
Boal Galena Hulla
C-3 R12 C

LITOS
Ártico Siberia Sabana
C-3 R12 C

PROVENZA
Bianco Navona Grigio Nebbia
C-1/C-3 R9/R12 -/C

Peldaño ML 150
33 x 150 x 4 cm - 13.0" x 59.1" x 1.6"
13 mm rectificado.rectified

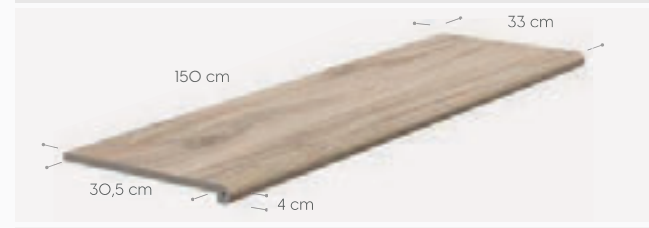

LIZANA
Haya Cerezo Olivo Nogal
C-3 R12 C

Piezas vaso piscina] Pool basin pieces

Media caña 8
7,7 x 66,5 cm - 3.0" x 26.2"
Arista 8
7,7 x 66,5 cm - 3.0" x 26.2"

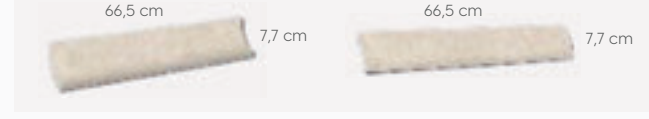

Uña media caña 8
7,7 x 7,7 cm - 3.0" x 3.0"
Uña arista 8
7,7 x 7,7 cm - 3.0" x 3.0"

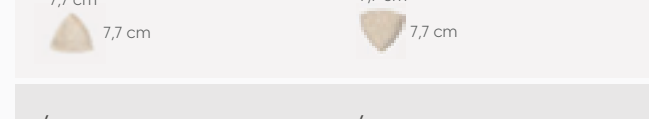

Áng. media caña 8
7,7 x 7,7 x 11 - 3.0" x 3.0" x 4.3"
Ángulo arista 8
7,7 x 7,7 x 11 cm - 3.0" x 3.0" x 4.3"

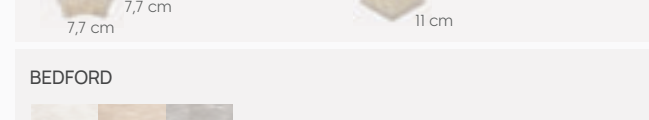

BEDFORD
White Sand Pearl

Media caña 4
4,2 x 33 cm - 1.7" x 13.0"
Arista 3
3,3 x 33 cm - 1.3" x 13.0"

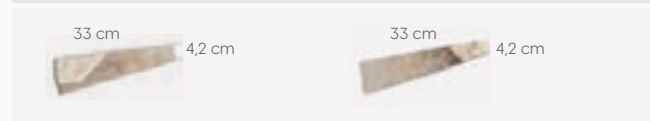

Uña media caña 4
4,2 x 4,2 cm - 1.7" x 1.7"
Uña arista 3
3,3 x 3,3 cm - 1.3" x 1.3"

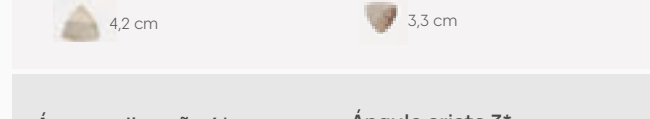

Áng. media caña 4*
4,2 x 3,3 x 5 cm - 1.7" x 1.3" x 2.0"
Ángulo arista 3*
3,3 x 4,2 x 5 cm - 1.3" x 1.7" x 2.0"

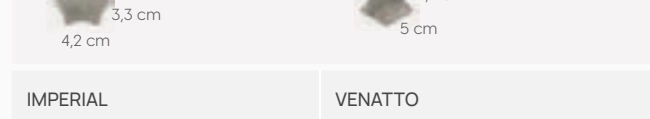

IMPERIAL
Arian Ceniza Moca Siena
VENATTO
Perla

NUBIA
Nubia
MARBLES
Calacatta Travertino Crema Marfil

ÓPERA
Ivory Light Silver Iron
LITOS
Ártico Siberia Sabana

*sólo series Imperial y Venatto. Imperial and Venatto series only.

Sistema de coronación skimmer. Esquemas de colocación.

Skimmer coping system. Placement diagrams. Couronnement skimmer. Schémas de pose.

Коронация скиммера. Схемы укладки

Borde skimmer Skimmer coping



- 1 Solera de hormigón. Concrete floor.
Dalle de béton. Бетонный пол.
- 2 Capa de regularización. Regularisation layer.
Couche de régularisation. Слой регуляризации.
- 3 Adhesivo tipo C2S2. Adhesive type C2S2.
Adhésif type C2S2. Тип клея C2S2.
- 4 Rejunte tipo CG2WA. CG2WA type grouting.
Coulis type CG2WA. Затирки типа CG2WA.
- 5 Bases cerámicas C-3. ceramic bases.
Bases céramiques C-3. Керамические основы C-3.
- 6 Junta elástica. Elastic joint.
Joint élastique. Эластичный шов.

- 7 Borde skimmer. Skimmer coping.
Bord skimmer. Бортик скиммер
- 8 Bases cerámicas 33x66,5 cm - C-1 en paredes.
Ceramic bases 33x66,5 cm - C-1 on walls. Bases céramiques 33x66,5 cm - C-1 sur murs. База 33x66,5 см - C-1 на стенах
- 9 Rejunte tipo RG de resinas reactivas. RG type grouting of reactive resins.
Injection de type RG de résines réactives. Затирка реактивных смол типа RG.
- 10 Media caña 4x33 cm. Internal cove 4x33 cm. Demi canne 4x33 cm.
Полукруглый 4x33 см.
- 11 Bases cerámicas 33x66,5 cm - C3 en fondo.
Ceramic bases 33x66,5 cm - C3 at bottom. Bases céramiques 33x66,5 cm - C3 au fond. Основание 33x66,5 см - C3 на дне
- 12 Junta hidroexpansiva. Hydroexpansive joint. Joint hydroexpansif.
Гидроэластичная прокладка.

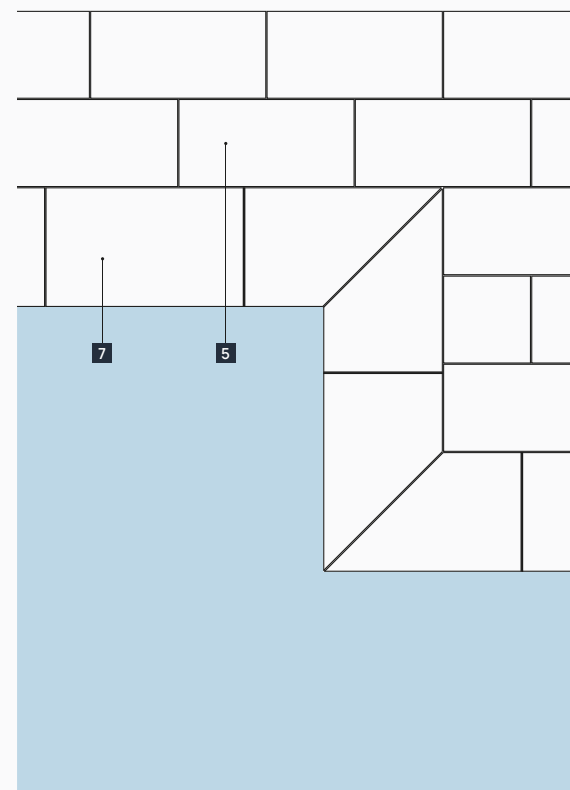
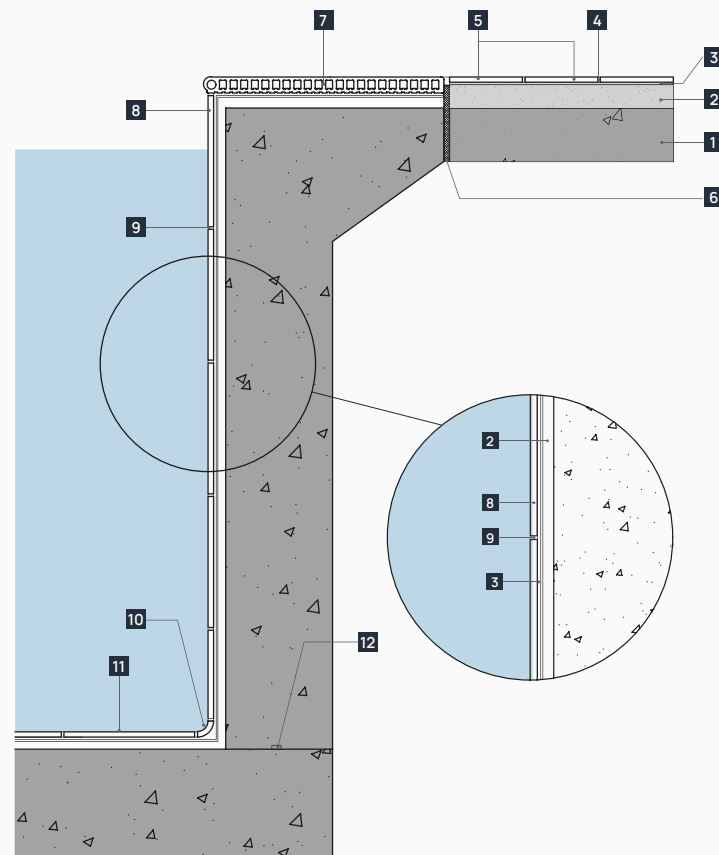

Imperial siena

- 7 Borde skimmer
45 x 75 x 3 cm - 17.7" x 29.5" x 1.2"

rectificado. rectified
C-3 R11 C

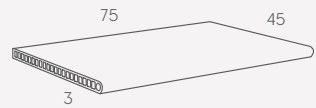

- 5 Base 60x120 cm
60 x 120 cm - 23.6" x 47.2"

C-3 R11 C

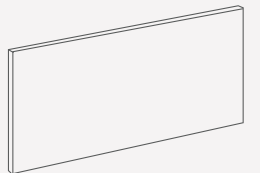

- 8 Base 33x66,5 cm
33 x 66,5 cm - 13.0" x 26.2"

C-1 R9



- 11 Base 33x66,5 cm
33 x 66,5 cm - 13.0" x 26.2"

C-3 R11 C



Sistema de coronación skimmer. Esquemas de colocación.

Skimmer coping system. Placement diagrams. Couronnement skimmer. Schémas de pose.

Коронация скиммера. Схемы укладки

Peldaño recto 120
120 Square tread step

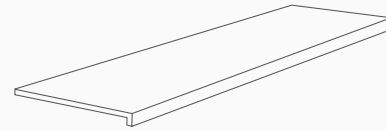

Peldaño recto 60
60 Square tread step

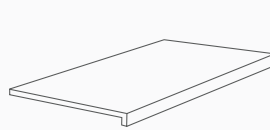

- 1 Solera de hormigón. Concrete floor.
Dalle de béton. Бетонный пол.
- 2 Capa de regularización. Regularisation layer.
Couche de régularisation. Слой регуляризации.
- 3 Adhesivo tipo C2S2. Adhesive type C2S2.
Adhésif type C2S2. Тип клея C2S2.
- 4 Rejunte tipo CG2WA. CG2WA type grouting.
Coulis type CG2WA. Затирки типа CG2WA.
- 5 Bases cerámicas C-3. ceramic bases.
Bases céramiques C-3. Керамические основы C-3.
- 6 Junta elástica. Elastic joint.
Joint élastique. Эластичный шов.

- 7 Coronación, peldaño recto 120 - 33x120 cm - C3. 120 Square step tread 33x120 cm - C3.
Marche recte 120 - 33x120 cm- C3. Ступень прямая 120 - 33x120 cm- C3.
- 8 Bases cerámicas 33x66,5 cm - C-1 en paredes. Ceramic bases 33x66,5 cm - C-1 on walls.
Bases céramiques 33x66,5 cm - C-1 sur murs. Керамические основания 33x66,5 cm - C-1 на стенах
- 9 Rejunte tipo RG de resinas reactivas. RG type grouting of reactive resins.
Injection de type RG de résines réactives. Затирка реактивных смол типа RG.
- 10 Media caña 4x33 cm. Internal cove 4x33 cm. Demi canne 4x33 cm.
Полукруглый 4x33 см.
- 11 Bases cerámicas 33x66,5 cm - C3 en fondo. Ceramic bases 33x66,5 cm - C3 at bottom.
Bases céramiques 33x66,5 cm - C3 au fond. Керамические основания 33x66,5 cm - C3 на дне
- 12 Junta hidroexpansiva. Hydroexpansive joint. Joint hydroexpansif.
Гидроэластичная прокладка.

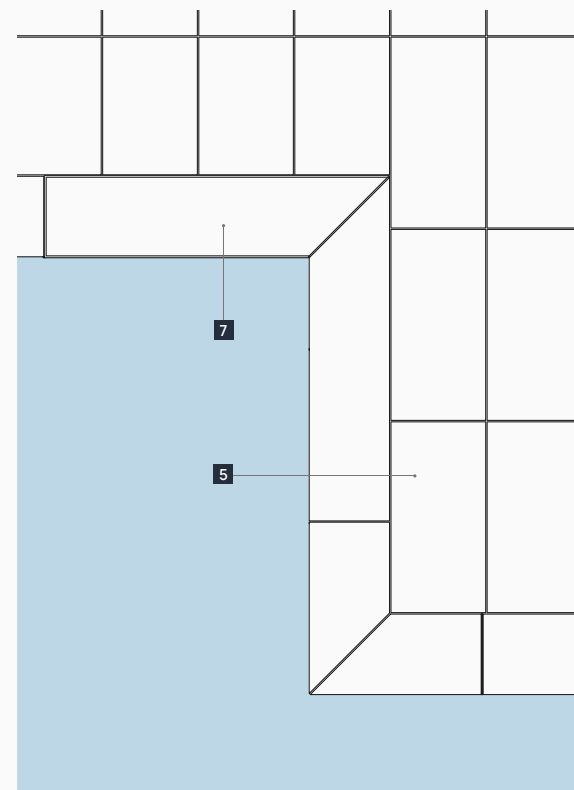
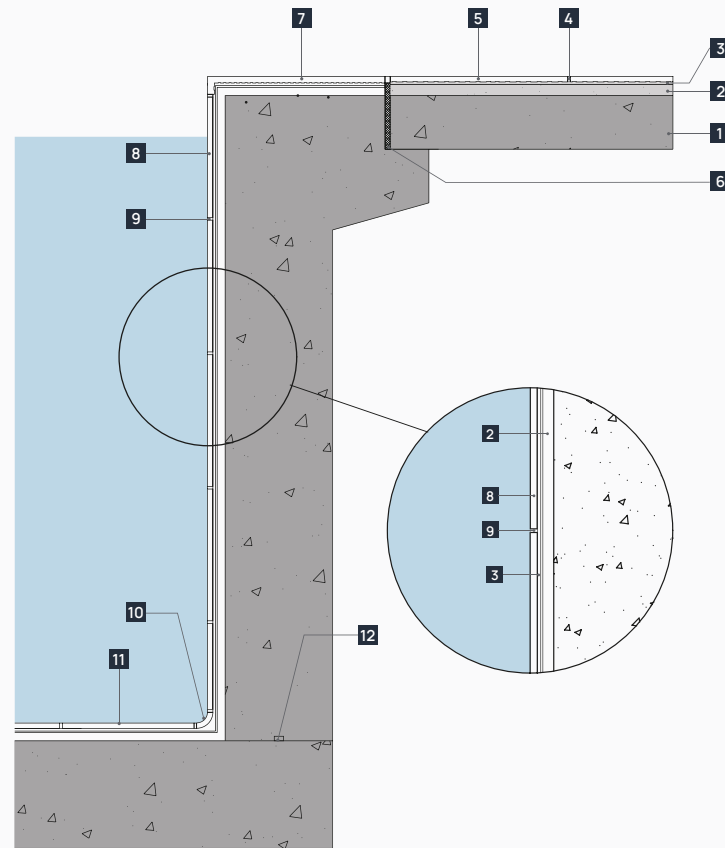

Ardenas cromo

7

Peldaño recto 120
33 x 120 x 3 cm - 13.0" x 47.2" x 1.2"

rectificado. rectified

C-3 R12 C

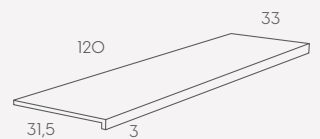

5

Base 60x120 cm
60 x 120 cm - 23.6" x 47.2"

C-3 R12 C

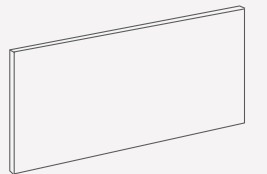

8

Base 33x66,5 cm
33 x 66,5 cm - 13.0" x 26.2"

C-1 R9



11

Base 33x66,5 cm
33 x 66,5 cm - 13.0" x 26.2"

C-3 R12 C



Piscinas residenciales]

Residential pools. Piscines résidentielles.
Жилые бассейны.



Sistema de coronación desbordante

Overflow coping system.

En este tipo de piscinas el agua rebosa el borde consiguiendo un efecto visual espectacular. El agua desborda y cae a un canal que la conduce hacia el sistema de filtrado. Gracias al flujo de agua de la piscina hacia el canal, hay una corriente importante de agua en la superficie, que arrastra las hojas y demás impurezas e impide que se depositen en el fondo. El flujo constante de agua hace que la suciedad superficial se elimine de forma rápida.

Este movimiento constante de agua hace que las piscinas desbordantes prácticamente no requieran limpieza de fondo, ya que la mayor parte de la suciedad es arrastrada hacia el canal y no llega a depositarse en el fondo. Por este motivo son muy utilizadas en piscinas de carácter público y recreativo (hoteles, spas, centros termales,....) donde se requiere una limpieza del agua constante.

In this type of pool, the water spills over the edge, creating an incredible visual effect. The water overflows and falls into a channel that passes it through the filtering system. The constant flow of the pool's water towards the channel stops leaves and other impurities from sinking to the bottom of the pool, helping quickly eliminate any surface dirt. This continual movement of the water means that overflow pools hardly ever require a deep clean as the majority of the dirt is washed away to the channel instead of sinking to the bottom of the pool. This means that they are often used as public pools, such as in hotels, spas and resorts, which require the water to be constantly cleaned.

Dans ce type de piscine, l'eau déborde du bord, créant un effet visuel spectaculaire. L'eau déborde et tombe dans un canal qui mène au système de filtrage. Grâce à l'écoulement de l'eau de la piscine dans le canal, il y a un flux d'eau important en surface, qui entraîne les feuilles et autres impuretés et les empêche de se déposer sur le fond. Le flux constant d'eau permet d'éliminer rapidement la saleté de surface.

Ce mouvement constant de l'eau signifie que les piscines à débordement ne nécessitent pratiquement aucun nettoyage du fond, car la plupart des saletés sont entraînées dans le canal et ne se déposent pas au fond. Pour cette raison, ils sont largement utilisés dans les piscines publiques et récréatives (hôtels, spas, centres thermaux,) où un nettoyage constant de l'eau est nécessaire.

В бассейнах этого типа вода переливается через край, создавая впечатляющий визуальный эффект. Вода переливается через край и попадает в канал, который ведет к системе фильтрации. Благодаря поступлению воды из бассейна в канал, на поверхности образуется значительный поток воды, который уносит листья и другие загрязнения и не дает им осесть на дно. Благодаря постоянному потоку воды поверхностные загрязнения удаляются быстро. Это постоянное движение воды означает, что переливные бассейны практически не требуют очистки дна, поскольку большая часть грязи затягивается в канал и не оседает на дно. По этой причине они широко используются в общественных и рекреационных бассейнах (гостиницы, спа, термальные центры,), где требуется постоянная очистка воды.



Piscinas residenciales. Sistema de coronación desbordante

Residential pools: overflow coping system. Piscines résidentielles: overflow système.

Технические решения: Жилые бассейны



1

Rejilla
24,5 x 66,5 cm
9.6" x 26.2"

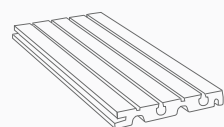

2

Borde desbordante
28 x 66,5 cm
11.0" x 26.2"

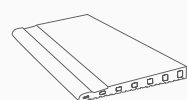

1

Rejilla modular
24,5 x 30 cm
9.6" x 11.8"

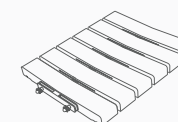

2

Áng. rejilla modular
30 x 30 cm
11.8" x 11.8"



3

Borde desbordante
28 x 66,5 cm
11.0" x 26.2"

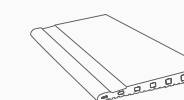

4

Ángulo desbordante
31 x 31 cm
12.2" x 12.2"



5

Arista 8
7,7 x 66,5 cm
3.0" x 26.2"



6

Ángulo arista 8
7,7 x 7,7 x 11 cm
3.0" x 3.0" x 4.3"



Piscinas residenciales. Sistema de coronación desbordante

Residential pools: overflow coping system. Piscines résidentielles: overflow systeme.

Технические решения: Жилые бассейны

Piezas coronación piscina

Coping system pieces

Borde desbordante
28 x 66,5 cm - 11.0" x 26.2"
rectificado. rectified

Ángulo desbordante
31 x 31 cm - 12.2" x 12.2"
rectificado. rectified

IMPERIAL
Arian Ceniza Moca Siena
C-3 R11 C

VENATTO
Perla
C-3 R11 C

LIZANA
Haya Cerezo Olivo Nogal
C-3 R12 C

ÓPERA
Ivory Light Silver Iron
C-3 R12 C

BEDFORD
White Sand Pearl
C-3 R12 C

ARDENAS
Marfil Cromo Gris Antracita
C-3 R12 C

PROVENZA
Bianco Navona Grigio Nebbia
C-3 R12 C

Rejilla modular
24,5 x 30 cm - 9.6" x 11.8"
rectificado. rectified

Áng. rejilla modular
30 x 30 cm - 1.8" x 11.8"
rectificado. rectified

Set de 6 piezas desmontables de 4,02x24,5 cm.
Set of 6 detachable pieces 4,02x24,5 cm.

BEDFORD
White Sand Pearl
C-3 R12 C

PROVENZA
Bianco Navona Grigio Nebbia
C-3 R12 C

Rejilla
24,5 x 24,5 cm - 9.6" x 9.6"
rectificado. rectified

IMPERIAL
Arian Ceniza Moca Siena
C-3 R11 C

VENATTO
Perla
C-3 R11 C

ÓPERA
Ivory Light Silver Iron
C-3 R12 C

LITOS
Ártico Siberia Sabana
C-3 R12 C

Rejilla
24,5 x 66,5 cm - 9.6 x 26.2"
rectificado. rectified

LIZANA
Haya Cerezo Olivo Nogal
C-3 R12 C

Ángulo rejilla
33 x 33 cm - 13.0" x 13.0"
rectificado. rectified

IMPERIAL
Arian Ceniza Moca Siena
C-3 R11 C

VENATTO
Perla
C-3 R11 C

LIZANA
Haya Cerezo Olivo Nogal
C-3 R12 C

ÓPERA
Ivory Light Silver Iron
C-3 R12 C

LITOS
Ártico Siberia Sabana
C-3 R12 C

Piezas vaso piscina

Pool basin pieces

Media caña 8
7,7 x 66,5 cm - 3.0" x 26.2"
7,7 cm

Arista 8
7,7 x 66,5 cm - 3.0" x 26.2"
7,7 cm

Uña media caña 8
7,7 x 7,7 cm - 3.0" x 3.0"
7,7 cm

Ángulo arista 8
7,7 x 7,7 x 11 cm - 3.0" x 3.0" x 4.3"
7,7 cm

Áng. media caña 8
7,7 x 7,7 x 11 cm - 3.0" x 3.0" x 4.3"
11 cm

BEDFORD
White Sand Pearl

Media caña 4
4,2 x 33 cm - .7" x 13.0"
4,2 cm

Arista 3
3,3 x 33 cm - 1.3" x 13.0"
3,3 cm

Uña media caña 4
4,2 x 4,2 cm - 1.7" x 1.7"
4,2 cm

Uña arista 3
3,3 x 3,3 cm - 1.3" x 1.3"
3,3 cm

Ángulo arista 3*
3,3 x 4,2 x 5 cm
1.3" x 1.7" x 2.0"
3,3 cm

Áng. media caña 4*
4,2 x 3,3 x 5 cm
1.7" x 1.3" x 2.0"
5 cm

*sólo series Imperial y Venatto *Imperial and Venatto series only

IMPERIAL
Arian Ceniza Moca Siena

VENATTO
Perla

LIZANA
Haya Cerezo Olivo Nogal

ÓPERA
Ivory Light Silver Iron

LITOS
Ártico Siberia Sabana

Sistema de coronación desbordante. Esquemas de colocación.

Overflow coping system. Placement diagrams. Couronnement skimmer. Schémas de pose.

Коронация скиммера. Схемы укладки

Borde desbordante Overflow coping

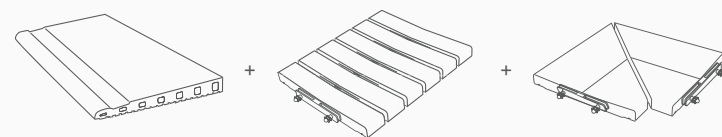

- 1 Borde desbordante 28x66,5. Overflow coping 28x66,5.
Bord débordant 28x66,5. Переливной край 28x66,5.
- 2 Rejilla modular 24,5x30. Modular grid 24,5x30.
Grille modulaire 24,5x30. Модульная решетка 24,5x30.
- 3 Base cerámica 33x66,5 (C-3). Ceramic bases 33x66,5 (C-3).
Bases céramiques 33x66,5 (C-3). Керамические основы 33x66,5 (C-3).
- 4 Borde desbordante corte a 45° para esquina. Overflow coping 45° corner cut.
Bord de débordement Bord d'angle courbé à 45. переливной край 45° срезанный угловой край. s.
- 5 Ángulo rejilla modular 30x30. Modular grid angle 30x30.
Angle de grille modulable. Модульный угол решетки.
- 6 Ángulo desbordante 31x31. Overflow corner 31x31.
Angle de débordement 31x31. Угол переливной 31x31.

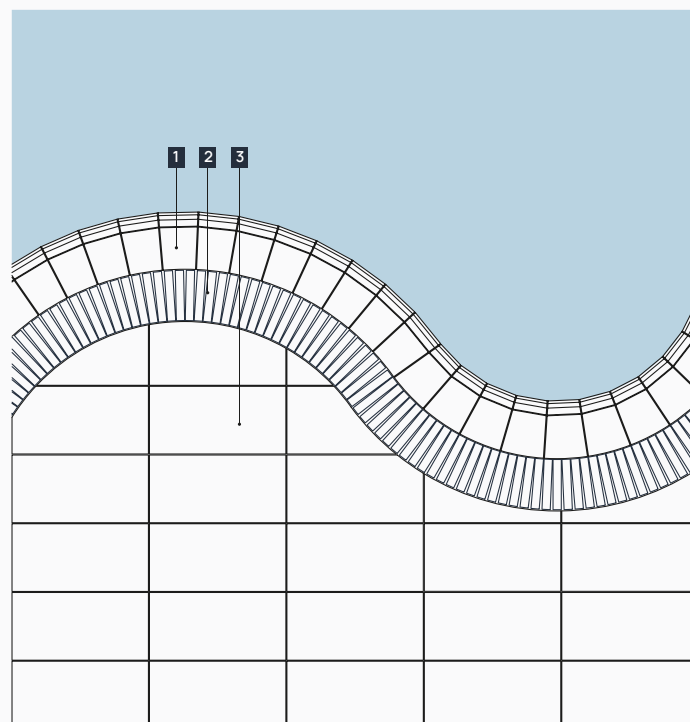
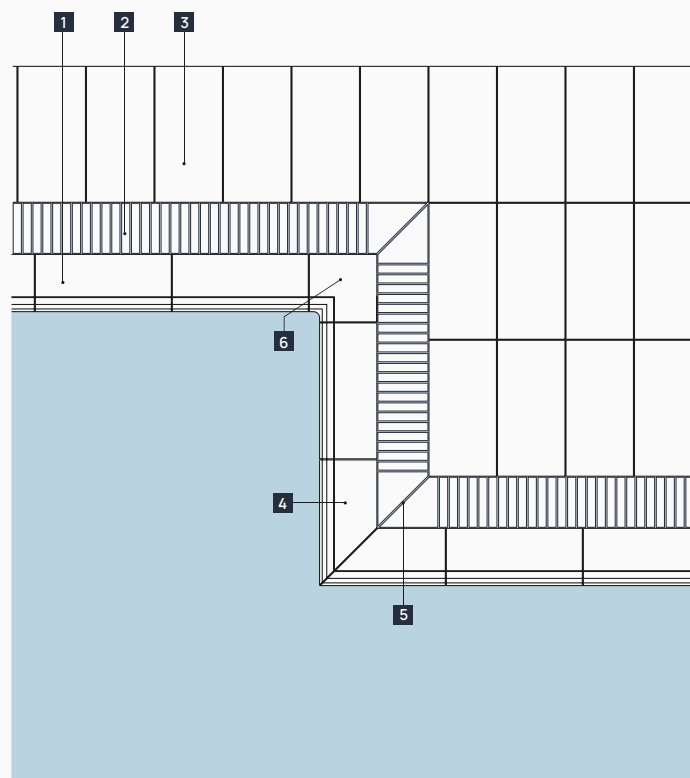

La parte superior de la rejilla modular es coplanaria con el resto de elementos del conjunto.
The upper part of the modular grid is coplanar with the rest of the elements of the assembly.
La partie supérieure de la grille modulaire est coplanaire avec le reste des éléments de l'ensemble.
Верхняя часть модульной решетки копланарна с остальными элементами сборки.

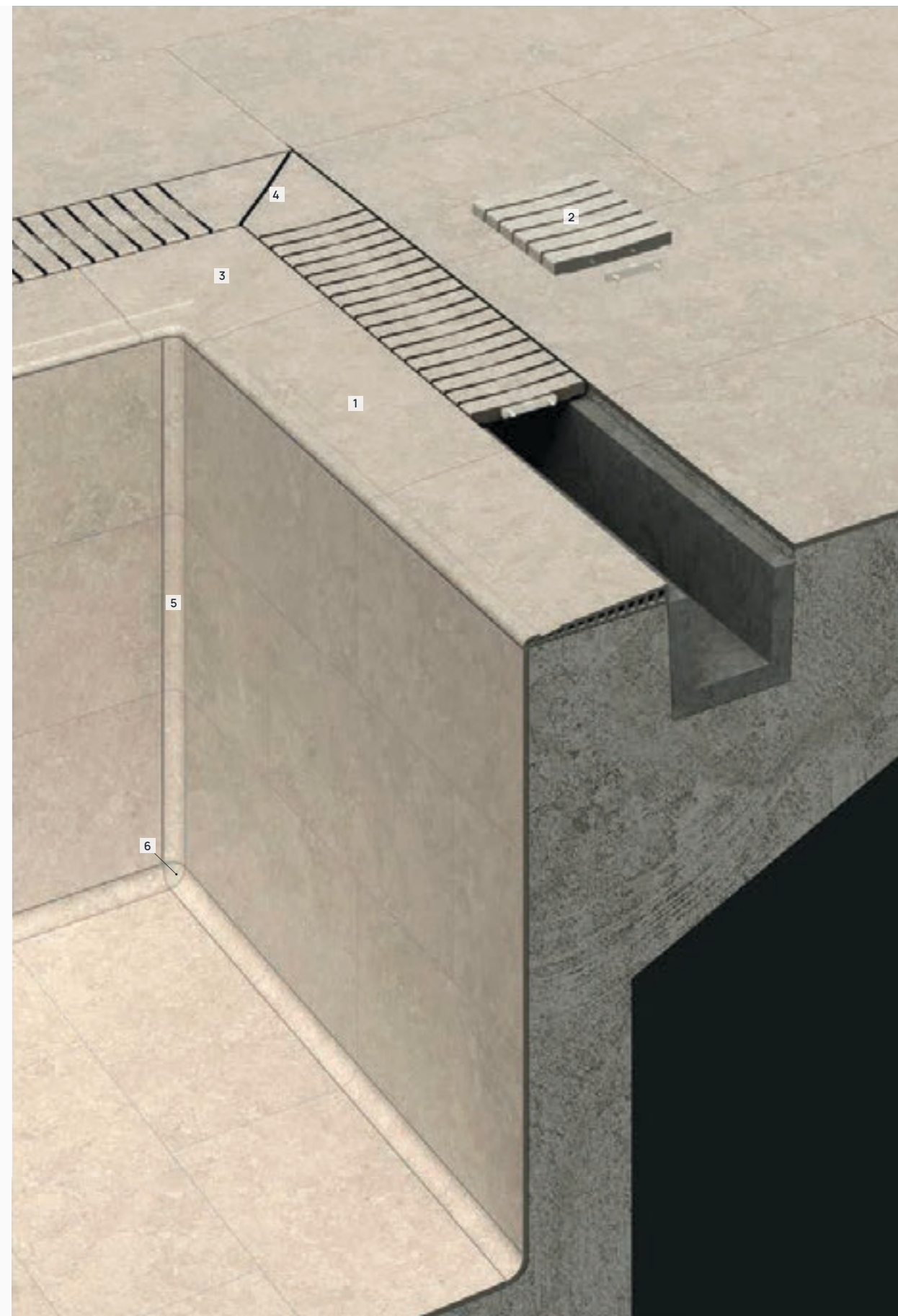

bedford sand

- 1 Borde desbordante
28 x 66,5 cm - 11.0" x 26.2"

rectificado. rectified
C-3 R12 C

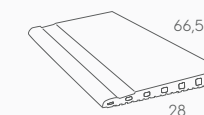

- 2 Rejilla modular
24,5 x 30 cm - 9.6" x 11.8"

rectificado. rectified
C-3 R12 C

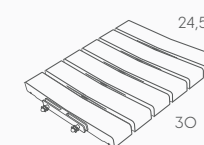

- 3 Ángulo desbordante
31 x 31 cm - 12.2" x 12.2"

rectificado. rectified
C-3 R12 C

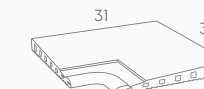

- 4 Ángulo rejilla modular
30 x 30 cm - 11.8" x 11.8"

rectificado. rectified
C-3 R12 C



- 5 Media caña 8
7,7 x 66,5 cm - 3.0" x 26.2"



- 6 Uña media caña 8
7,7 x 7,7 cm - 3.0" x 3.0"



Sistema de coronación desbordante. Esquemas de colocación.

Overflow coping system. Placement diagrams. Couronnement skimmer. Schémas de pose.

Коронация скиммера. Схемы укладки

Borde desbordante Overflow coping

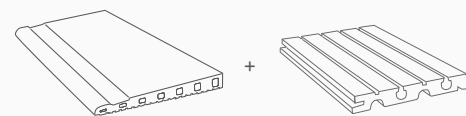

- 1 Solera de hormigón 10 cm espesor. Concrete floor 10 cm thick.
Dalle de béton de 10 cm d'épaisseur. Бетонная плита толщиной в 10 см.
- 2 Capa de regulación. Regulation layer.
Couche réglementaire. Нормативный уровень.
- 3 Adhesivo tipo C2S2. Adhesive type C2S2.
Adhésif type C2S2. Тип клея C2S2.
- 4 Rejunte tipo CG2WA. CG2WA type grouting.
Coulis type CG2WA. Затирки типа CG2WA.
- 5 Bases cerámica C-3. C-3 ceramic bases.
Bases céramiques C-3. Керамические основы C-3.
- 6 Junta elástica. Elastic joint.
Joint élastique. Эластичный шов.
- 7 Rejilla cerámica 24,5x24,5 - C3. Ceramic grid 24,5x24,5 - C3.
Grille céramique 24,5x24,5 - C3. Керамическая решетка 24,5x24,5 - C3.
- 8 Borde desbordante 28x66,5 - C3. Overflow coping 28x66,5 - C3.
Bord débordant 28x66,5 - C3. Переливной край 28x66,5 - C3.

- 9 Ángulo rejilla cerámica izda./dcha. - C3. Ceramic grid - C3.
Grille céramique - C3. Керамическая решетка - C3.
- 10 Ángulo desbordante C3. Overflow corner C3.
Angle de débordement - C3. Угол переливной C3.
- 11 Junta hidroexpansiva. Hydroexpansive joint. Joint hydroexpansif.
Гидроэластичная прокладка.
- 12 Bases cerámicas 33x66,5 cm - C-1 en paredes. Ceramics bases 33x66,5 cm - C-1 on walls. Base 33x66,5 cm - C-1 sur murs. База 33x66,5 см - C-1 на стенах
- 13 Rejunte tipo RG de resinas reactivas. RG type grouting of reactive resins.
Injection de type RG de résines réactives. Затирка реактивных смол типа RG.
- 14 Media caña 4. Internal cove 4. Demi canne 4.
Полукруглый 4.
- 15 Capa de impermeabilización. Waterproofing layer. Couche imperméable.
Гидроизоляционный слой.
- 16 Capa de adhesivo cementoso tipo C2S2. Cementitious adhesive layer type C2S2.
Couche de ciment adhésif de type C2S2. Цементный слой клея типа C2S2.

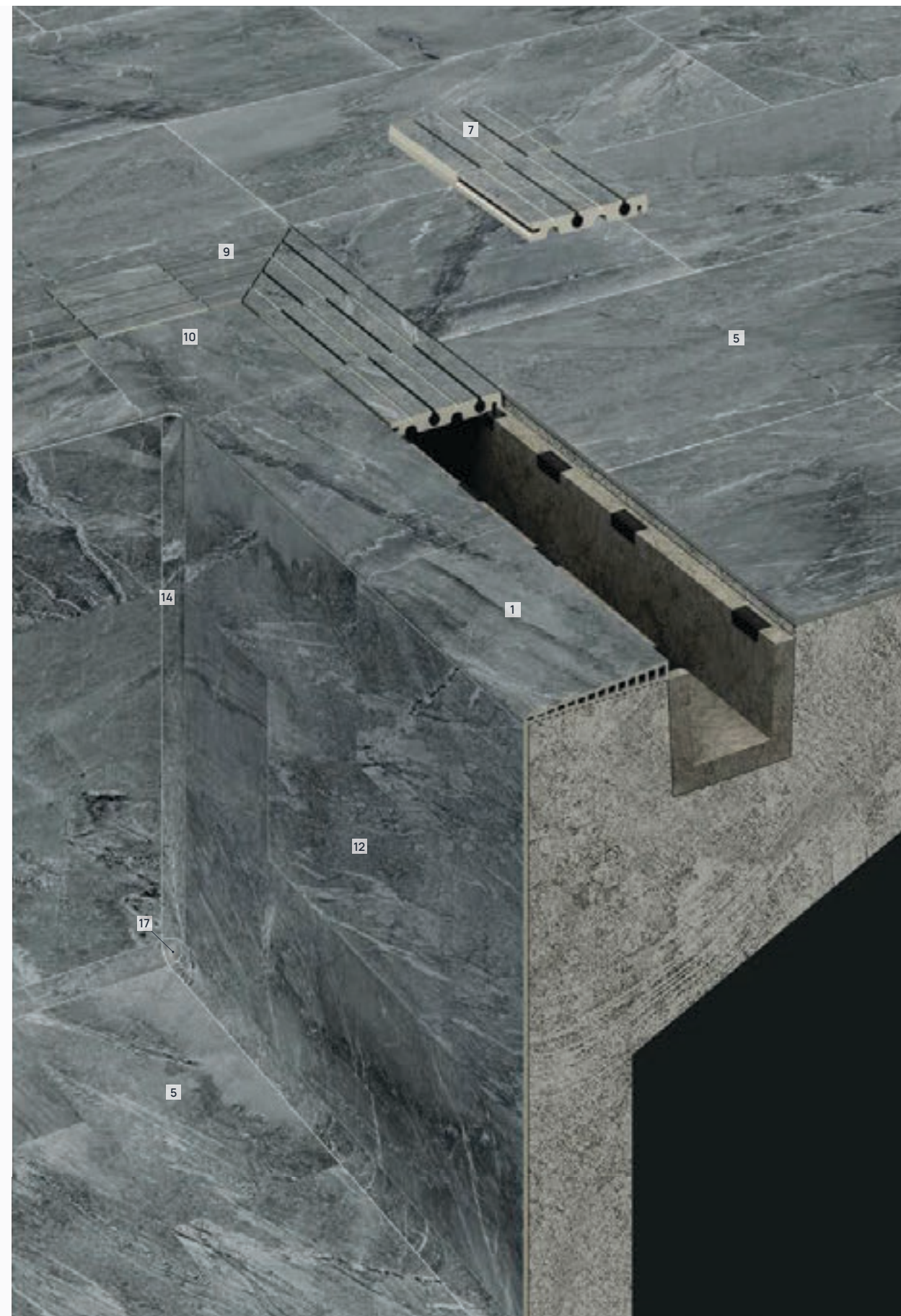
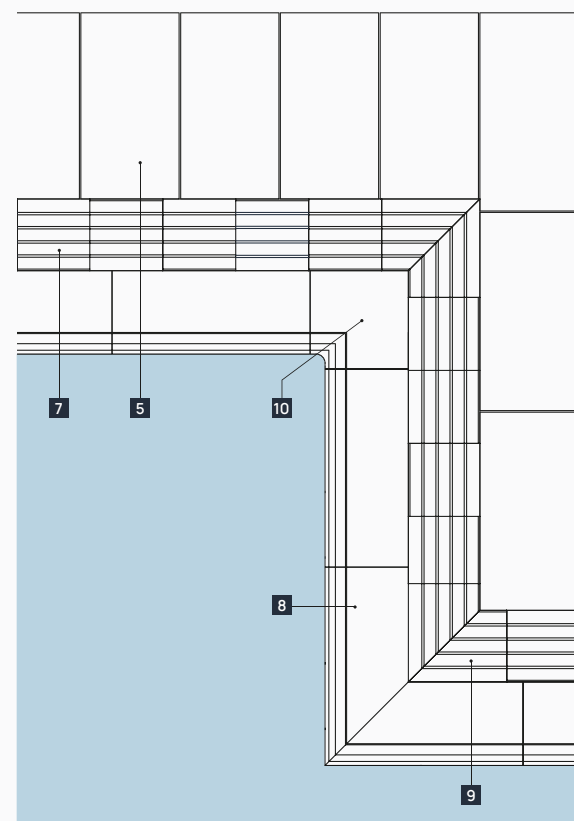
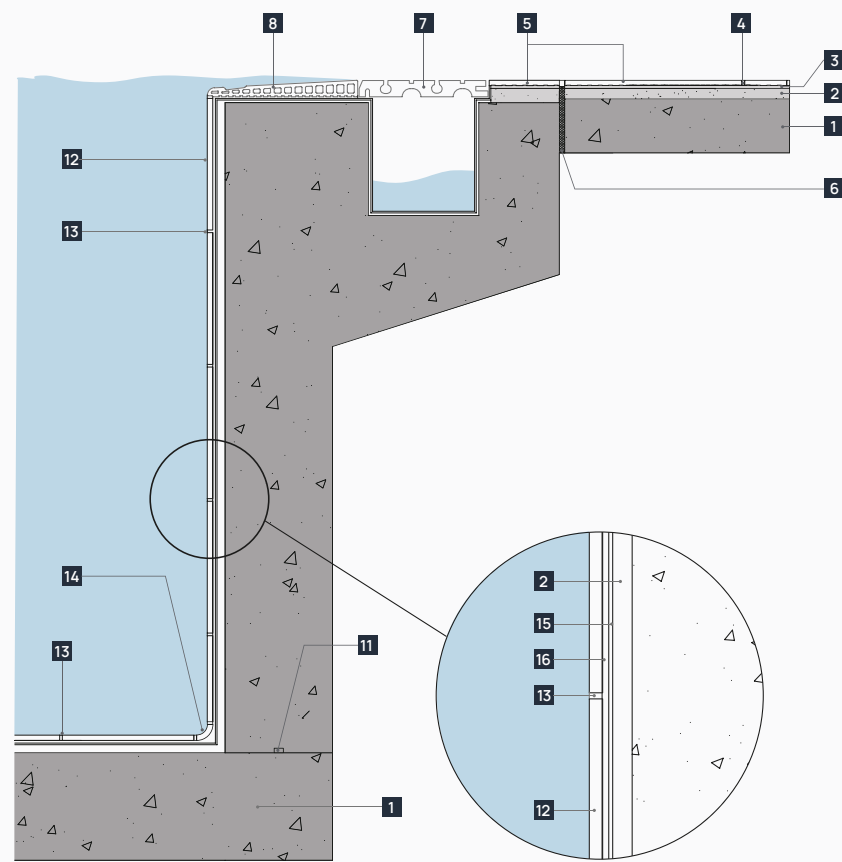

Imperial ceniza

- 8 Borde desbordante
28 x 66,5 cm - 11.0" x 26.2"

rectificado. rectified
C-3 R11 C

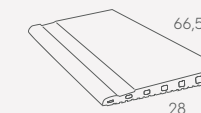

- 7 Rejilla
24,5 x 24,5 cm - 9.6" x 9.6"

rectificado. rectified
C-3 R11 C

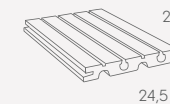

- 10 Ángulo desbordante
31 x 31 cm - 12.2" x 12.2"

rectificado. rectified
C-3 R11 C



- 9 Ángulo rejilla
33 x 33 cm - 13.0" x 13.0"

rectificado. rectified
C-3 R11 C

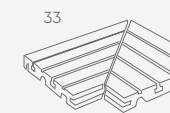

- 14 Media caña 4
4,2 x 33 cm - 1.7" x 13.0"

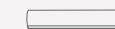

- 17 Uña media caña 4
4,2 x 4,2 cm - 1.7" x 1.7"



VIDEO COLOCACIÓN REJILLAS.
INSTALLATION OF GRATINS VIDEO

Piscinas residenciales]

Residential pools. Piscines résidentielles.
Жилые бассейны.



Piscinas infinity Infinity pools

Aquellas piscinas en las que el efecto desbordante se produce generalmente, en parte del perímetro de la piscina. Por ejemplo, en una piscina rectangular, desborde por uno, dos o tres lados de la piscina. Recibe su nombre gracias al efecto óptico que produce el no ver dónde acaba, por dónde se va el agua. Así, si nos encontramos en una zona junto al mar, puede llegar a dar la sensación de que continúa con el agua del mar, de ahí lo de infinito. Habitualmente, el agua suele rebasar el borde y caer verticalmente desde mayor o menor altura, sobre una canaleta que puede actuar como depósito de compensación o únicamente como parte del circuito, a un vaso de compensación oculto. Destacan por su gran atractivo estético.

These pools create an overflowing effect around the edge of the pool, with the water flowing over either one, two or three of the pool's sides, in the case of a rectangular pool. Its name comes from the optical effect produced as a result of not being able to see where the pool ends and where the water goes. If you place one of these pools near the sea, for example, it gives the sensation that the pool runs straight into the sea, a sensation of infinity. Normally, the water flows over the edge and falls vertically into a channel which acts either as a balance tank or forms part of a hidden balance system. These pools stand out thanks to their aesthetic design.

Les piscines où l'effet de débordement se produit généralement sur une partie du périmètre de la piscine. Par exemple, dans une piscine rectangulaire, débordant sur un, deux ou trois côtés de la piscine. Il tire son nom de l'effet d'optique qui consiste à ne pas voir où l'eau se termine. Ainsi, si nous nous trouvons dans une zone proche de la mer, celle-ci peut donner la sensation de se prolonger avec l'eau de mer, d'où le nom d'infini. Habituellement, l'eau déborde du bord et tombe verticalement d'une hauteur plus ou moins grande, sur un canal qui peut faire office de réservoir de compensation ou seulement de partie du circuit, vers un réservoir de compensation caché. Ils se distinguent par leur grand attrait esthétique.

Бассейны, в которых эффект перелива обычно возникает на части периметра бассейна. Например, в прямоугольном бассейне переполнение происходит содной, двух или трех сторон бассейна. Свое название он получил благодаря оптическому эффекту, когда не видно, где заканчивается вода. Так, если мы находимся в зоне рядом с морем, может возникнуть ощущение, что оно продолжается морской водой, отсюда и название бесконечность. Обычно вода переливается через край и падает вертикально с большей или меньшей высоты, через канал, который может выступать в качестве компенсационного резервуара или только как часть контура, в скрытый компенсационный резервуар. Они выделяются своей большой эстетической привлекательностью.



Sistema infinity. Esquemas de colocación.

Infinity system. Placement diagrams. Couronnement infinity. Schémas de pose. Коронация скиммера. Коронация.



Peldaño recto 120
120 Square tread step

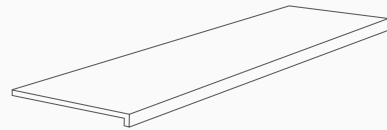

Peldaño recto 60
60 Square tread step

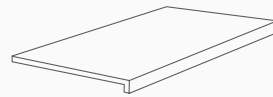

- 1 **Coronación, peldaño recto 120 - 33x120 cm - C3.** 120 Square step tread 33x120 cm - C3. Marche recte 120 - 33x120 cm - C3. Ступень прямая 120 - 33x120 cm - C3.
- 2 **Bases cerámicas 60x120 - C-1.** C-1 60x120 ceramic bases. Bases 60x120 - C-1. Керамические основы 60x120 - C-1.
- 3 **Capa de adhesivo cementoso tipo C2S2.** Cementitious adhesive layer type C2S2. Couche de ciment adhésif de type C2S2. Цементный слой клея типа C2S2.
- 4 **Rejunte tipo CG2WA.** Grouting for ceramic tiles. Jointoiment pour les carreaux de céramique. Затирка керамической плитки.
- 6 **Solera de hormigón.** Concrete floor. Dalle de béton. Бетонная стяжка.
- 7 **Capa de regulación.** Regulation layer. Couche réglementaire. Нормативный уровень.
- 8 **Capa de impermeabilización.** Waterproofing layer. Couche imperméable. Гидроизоляционный слой.
- 9 **Rejunte tipo RG de resinas reactivas.** RG type grouting of reactive resins. Injection de type RG de résines réactives. Затирка реактивных смол типа RG.
- 10 **Junta con material compresible.** Seal with compressible material. Joint d'étanchéité avec matériau compressible. Прокладка со сжимаемым материалом.
- 11 **Junta elástica.** Elastic joint. Joint élastique. Эластичный шов.
- 12 **Paredes del vaso.** Basin walls - Parois des vaisseaux. Стенки сосудов.
- 13 **Media caña 4x33 cm.** Internal cove 4x33 cm. Demi canne 4x33 cm. Полукруглый 4x33 см.
- 14 **Rejilla cerámica 24,5x24,5 cm canal desbordante.** Ceramic grating 24,5x24,5 cm overflow channel. Grille en céramique 24,5x24,5 cm canal de débordement. Керамическая решетка 24,5x24,5 см переливной канал.

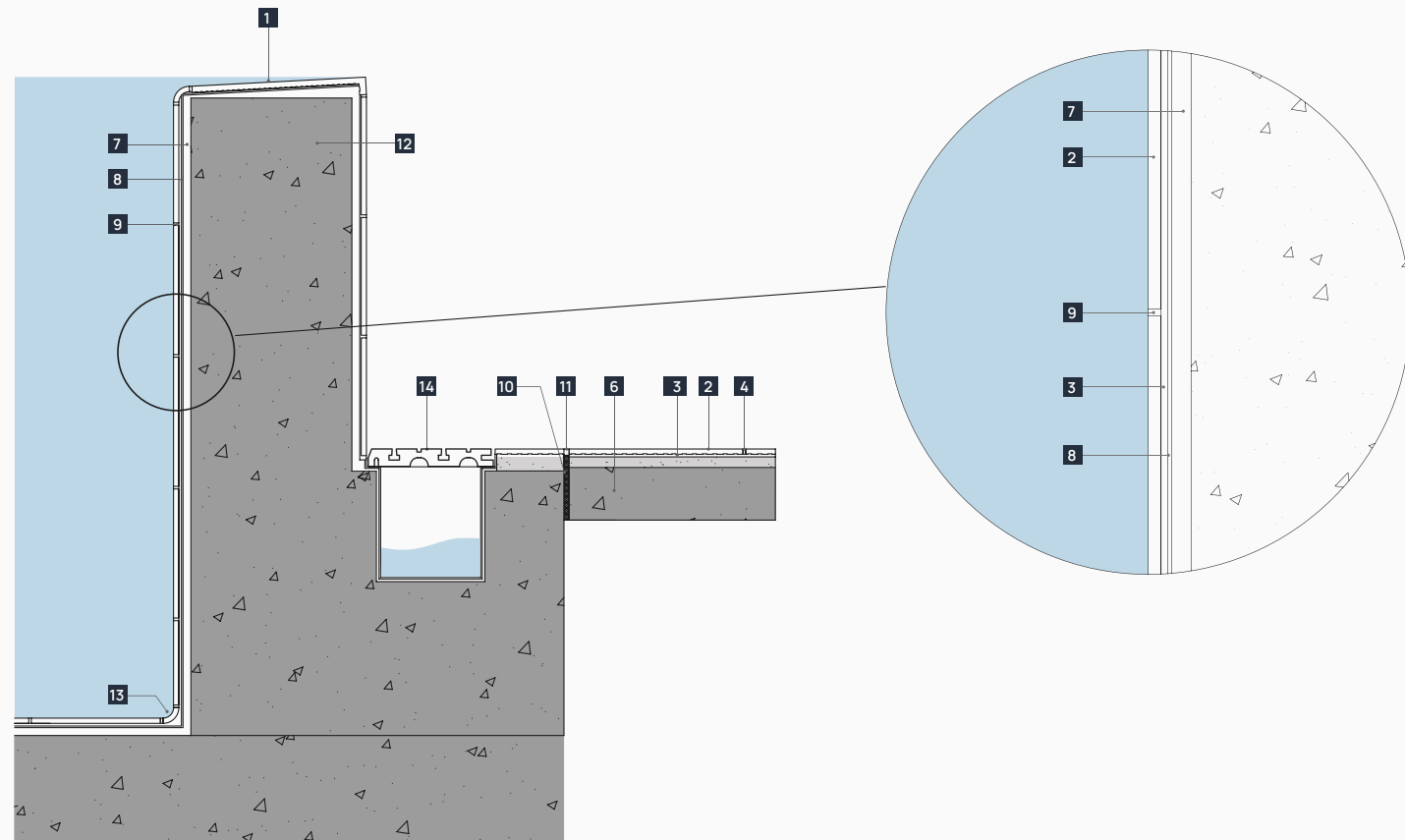

Ardenas marfil

1
Peldaño recto 120
33 x 120 x 3 cm - 13.0" x 47.2" x 1.2"

rectificado. rectified

C-3 R12 C

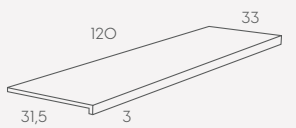

2
Base 60x120 cm
60 x 120 cm - 23.6" x 47.2"

C-1 R9

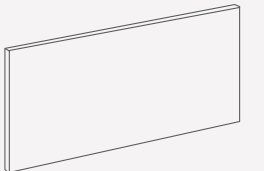

Piscinas residenciales: escaleras interiores.

Residential pools: interior stairs. Piscines résidentielles : escaliers intérieurs.

Жилые бассейны: внутренние лестницы.

El interior de la piscina, o vaso de piscina, tiene tanta importancia como el borde o la terraza. Es importante elegir bien el material que colocar. El material cerámico ofrece propiedades de durabilidad, facilidad de colocación y estética. Además es resistente a los productos químicos utilizados en el mantenimiento de la piscina y no tiene problemas de caída de piezas como ocurre con el gresite, ofreciendo una gran ventaja.

Para facilitar el uso de limpia fondos y favorecer la seguridad del usuario, Exagres propone un sistema de medias cañas, y aristas para poder terminar todas las zonas de esquinas y ángulos rectos y convirtiéndolos en curvos, para mejorar la limpieza y facilitar las terminaciones de bancos, escaleras o solárium de las piscinas.

The inside of the pool, or pool basin, is just as important as the edge or the terrace. It is important to choose the right material to install. Ceramic material offers properties of durability, ease of installation and aesthetics. It is also resistant to the chemical products used in the maintenance of the pool and does not have problems of falling pieces as happens with the gresite, offering a great advantage.

To facilitate the use of the cleaner and to promote the safety of the user, Exagres proposes a system of half-rounds and edges to be able to finish all the areas of corners and right angles and turning them into curves, to improve cleaning and facilitate the finishing of benches, stairs or pool solariums.

L'intérieur de la piscine, ou bassin, est tout aussi important que le bord ou la terrasse. Il est important de choisir le bon matériau à installer. Le matériau céramique offre des propriétés de durabilité, de facilité d'installation et d'esthétique. Il est également résistant aux produits chimiques utilisés pour l'entretien de la piscine et ne présente pas de problèmes de chute de morceaux comme c'est le cas avec la grésite, ce qui constitue un grand avantage.

Pour faciliter l'utilisation des nettoyeurs de fond et améliorer la sécurité des utilisateurs, Exagres propose un système de demi-anneaux et de bords pour pouvoir finir toutes les zones de coins et d'angles droits et les transformer en courbes, pour améliorer le nettoyage et faciliter la finition des bancs, escaliers ou solarium des piscines.

Внутренняя часть бассейна, или бассейн, не менее важна, чем бортик или терраса. Важно выбрать правильный материал для установки. Керамический материал обладает такими свойствами, как долговечность, простота установки и эстетичность. Он также устойчив к химическим средствам, используемым при обслуживании бассейна, и не имеет проблем с падением кусков, как это происходит с грезитом, что является большим преимуществом.

Чтобы облегчить использование донной очистки, Exagres предлагает систему полукругностей и кромок, позволяющую отделывать все участки углов и прямых углов, превращая их в кривые, для улучшения очистки и облегчения отделки скамеек, лестниц или соляриев бассейнов.

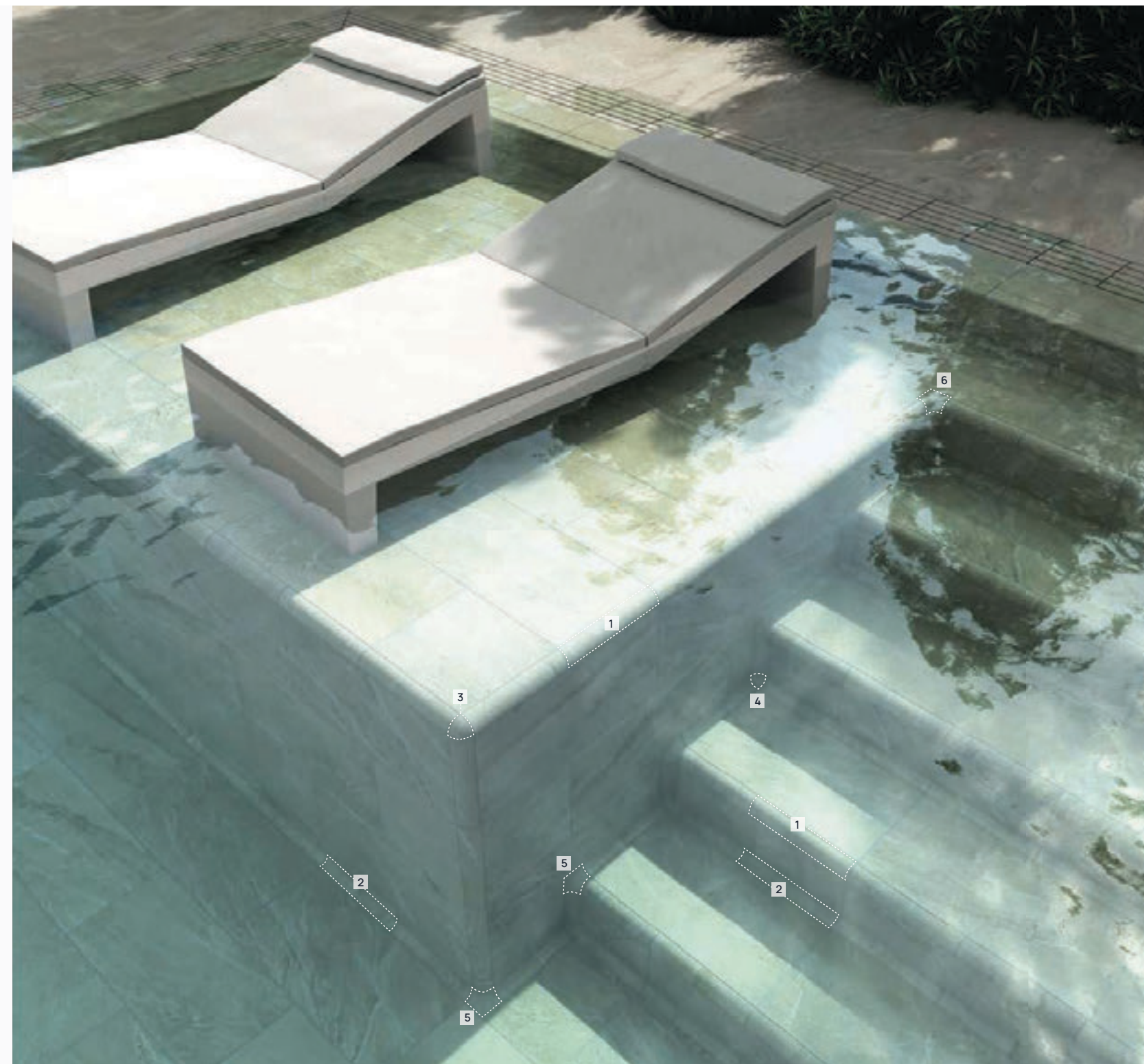

1	2	3	4	5	6
Arista 3	Media caña 4	Uña arista 3	Uña media caña 4	Áng. arista 3	Áng. media caña 4
3,3 x 33 cm	4,2 x 33 cm	3,3 x 3,3 cm	4,2 x 4,2 cm	3,3 x 4,2 x 5 cm	4,2 x 3,3 x 5 cm
1.3" x 13.0"	1.7" x 13.0"	1.3" x 1.3"	1.7" x 1.7"	1.3" x 7.0" x 2.0"	1.7" x 1.3" x 2.0"

Piscinas residenciales: piscinas curvas.

Residential pools: curved pools. Piscines résidentielles : piscines courbes.

Жилые бассейны: изогнутые бассейны.

Exagres ofrece soluciones para el diseño de piscinas con formas curvas o redondeadas, que las convierten en piscinas vistosas y cómodas para el baño, pero que añaden más complejidad en la construcción que las piscinas rectas. Exagres plantea una serie de piezas que se adaptan con facilidad a este tipo de piscinas.

La cantidad de piezas de cada modelo dependerá de las diferentes formas y medidas de cada piscina, según sus curvas exteriores, interiores o tramos rectos.

Exagres offers solutions for the design of swimming pools with curved or rounded shapes, which make them attractive and comfortable for swimming, but which add more complexity to the construction than straight pools. Exagres offers a series of pieces that adapt easily to this type of pool.

The number of pieces in each model will depend on the different shapes and sizes of each pool, depending on its outer curves, inner curves or straight sections.

Exagres propose des solutions pour la conception de piscines aux formes courbes ou arrondies, qui les rendent attrayantes et confortables pour la baignade, mais qui rendent la construction plus complexe que les piscines droites. Exagres propose une série de pièces qui s'adaptent facilement à ce type de piscine.

Le nombre de pièces de chaque modèle dépendra des différentes formes et tailles de chaque bassin, selon ses courbes extérieures, ses courbes intérieures ou ses sections droites.

Exagres предлагает решения для проектирования бассейнов изогнутой или округлой формы, что делает их привлекательными и удобными для плавания, но усложняет конструкцию по сравнению с прямыми бассейнами. Exagres предлагает серию изделий, которые легко адаптируются к этому типу бассейнов. Количество изделий в каждой модели будет зависеть от различных форм и размеров каждого бассейна, в зависимости от его внешних изгибов, внутренних изгибов или прямых участков.



Piscinas residenciales: piscinas con formas curvas.

Residential pools: pools with curved shapes. Piscines résidentielles : piscines aux formes courbes.

Жилые бассейны: Бассейны изогнутой формы



Sistema de coronación skimmer. Skimmer coping system.

Couronnement skimmer. Schémas de pose. Коронация скиммера. Схемы укладки

Bordes de coronación para piscinas con distintos radios de giro.

Coping edges for swimming pools with different turning radius.

Formar curva de 0,50 metros de radio aprox.
Form curve of approx. 0.50 m radius.

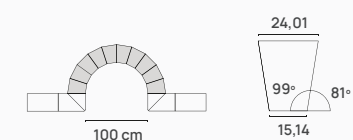

10 piezas pre-cortadas

Formar curva de 0,75 metros de radio aprox.
Form curve of approx. 0.75 m radius.

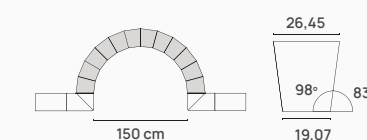

12 piezas pre-cortadas

Formar curva de 1 metro de radio aprox.
Form curve of approx. 1 m radius.

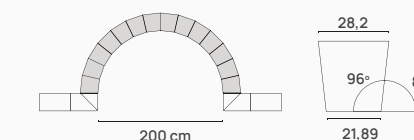

14 piezas pre-cortadas

Formar curva de 1,25 metros de radio aprox.
Form curve of approx. 1.25 m radius.

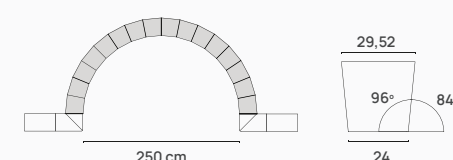

16 piezas pre-cortadas

Formar curva de 1,5 metros de radio aprox.
Form curve of approx. 1.5 m radius.

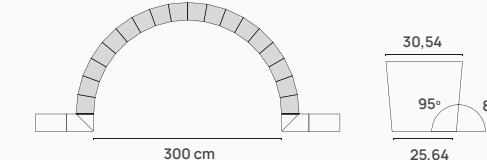

18 piezas pre-cortadas

Sistema de coronación desbordante. Overflow coping system.

Couronnement skimmer. Коронация скиммера. Схемы укладки

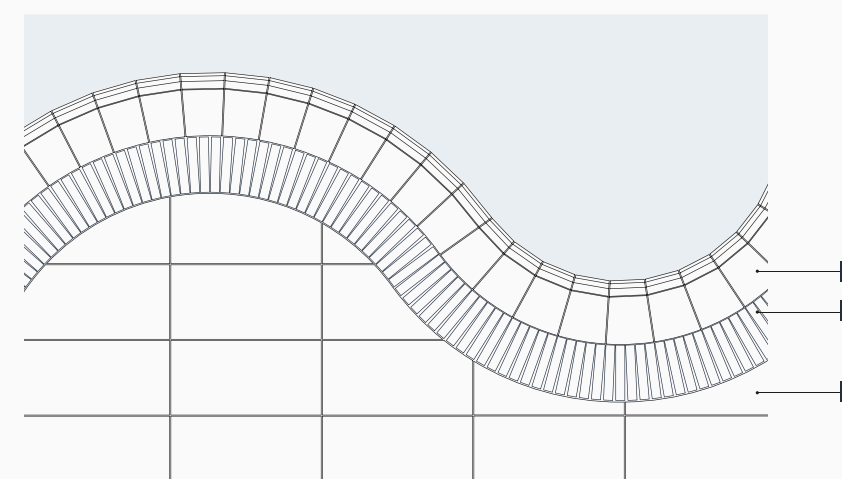

1. Borde desbordante 28x66,5. Overflow coping 28x66,5.
Bord débordant 28x66,5. Переливной край 28x66,5.
2. Rejilla modular 24,5x30. Modular grid 24,5x30.
Grille modulaire 24,5x30. Модульная решетка 24,5x30.
3. Base cerámica 33x66,5 (C-3). Ceramic bases 33x66,5 (C-3).
Bases céramiques 33x66,5 (C-3). Керамические основы 33x66,5 (C-3).

Contactar con el departamento técnico de Exagres para estudiar cada proyecto de piscina curva en concreto.
Contact the Exagres technical department to study each specific curved pool project.
Contactez le département technique d'Exagres pour étudier chaque projet spécifique de piscine courbe.
Свяжитесь с техническим отделом Exagres для изучения каждого конкретного проекта изогнутого бассейна.

Piscinas residenciales]

Residential pools. Piscines résidentielles.
Жилые бассейны.

¿De qué color se verá el agua de mi piscina? What colour will the water in my pool appear?

Hay muchos factores que influyen en el color con el que se verá el agua de nuestra piscina, como la profundidad del agua, la luz del lugar en el que se encuentra la piscina, el entorno, si es una piscina interior o exterior así como la iluminación utilizada.

A más volumen de agua y a más profundidad, más azul tenderá a verse la piscina. La luz del sol es también un factor importante, a más luminosidad, más clara se verá el agua mientras que una luz más tenue la oscurecerá. Si la piscina está rodeada de vegetación se verá más verde y oscura y si el paisaje que le rodea es desértico el agua parecerá más clara.

A parte de esto, otros de los factores determinantes va a ser el color del material utilizado para el vaso de la piscina. En este punto sí podrás personalizar tu piscina con estilo propio, eligiendo entre una amplia variedad de colores y texturas que te ofrece Exagres.

Te mostramos como funcionan nuestros colores combinados con el agua en diferentes lugares y momentos.

Lots of factors combine to influence the colour that the water will look in your pool, such as the depth of the water, the light where your pool is located, the surrounding environment, whether it's an indoor or outdoor pool, as well as the type of lighting used.

The more water in your pool and the deeper it is, the more blue the water will appear. Sunlight is also an important component, as the lighter it is, the lighter the water will be, while a dimmer light will lead to darker water. If the pool is surrounded by greenery, the water will be darker and greener, but if it is surrounded by desert, however, it will appear lighter.

In addition to this, the shade of tiles used for the basin of the pool will also help determine the water colour. This is one of the ways that you can personalise your pool to suit your tastes, choosing between Exagres' endless selection of colours and textures.

Let us tell you how to combine our colours to achieve different water colours in different places and at different times.

De nombreux facteurs influencent la couleur de l'eau de notre piscine, comme la profondeur de l'eau, la lumière où se trouve la piscine, l'environnement, s'il s'agit d'une piscine intérieure ou extérieure, ainsi que l'éclairage utilisé.

Plus le volume d'eau et la profondeur sont importants, plus la piscine a tendance à être bleue. La lumière du soleil est également un facteur important. Plus elle est claire, plus l'eau sera limpide, tandis qu'une lumière plus faible l'assombrit. Si la piscine est entourée de végétation, elle paraîtra plus verte et plus sombre, et si le paysage environnant est désertique, l'eau paraîtra plus claire.

En outre, un autre facteur déterminant sera la couleur du matériau utilisé pour la coque de la piscine. À ce stade, vous pourrez personnaliser votre piscine selon votre propre style, en choisissant parmi une grande variété de couleurs et de textures proposées par Exagres.

Nous vous montrons comment nos couleurs se combinent avec l'eau dans différents endroits et à différents moments.

Существует множество факторов, влияющих на цвет воды в нашем бассейне, таких как глубина воды, освещенность места, где расположен бассейн, окружающая среда, будь то крытый или открытый бассейн, а также используемое освещение.

Чем больше объем воды и глубина, тем более голубым выглядит бассейн. Солнечный свет также является важным фактором, чем он ярче, тем прозрачнее будет вода, в то время как тусклый свет затемняет ее. Если бассейн окружен растительностью, он будет выглядеть более зеленым и темным, а если окружающий ландшафт похож на пустыню, вода будет казаться светлее.

Помимо этого, еще одним определяющим фактором будет цвет материала, из которого изготовлена раковина бассейна. На этом этапе вы сможете придать своему бассейну индивидуальный стиль, выбрав из широкого разнообразия цветов и текстур, предлагаемых компанией Exagres.

Мы покажем вам, как наши краски работают в сочетании с водой в разных местах и в разное время.



AGUA COLOR AZUL CLARO:
LIGHT BLUE WATER:
EAU BLEU CLAIR :
СВЕТЛО-ГОЛУБАЯ ВОДА:

Para lograr una piscina en escala de azules claros Exagres propone los modelos Litos ártico, Marbles calacatta, Ópera ivory o Ardenas cromo.

To achieve a pool in a scale of light blues, Exagres proposes the Litos arctic, Marbles calacatta, Opera ivory or Ardenas cromo models.

Pour obtenir une piscine dans une gamme de bleus clairs, Exagres propose les modèles Litos arctic, Marbles calacatta, Opera ivory ou Ardenas cromo.

Для создания бассейна в гамме светло-голубых тонов Exagres предлагает модели Litos arctic, Marbles calacatta, Opera ivory или Ardenas cromo.



Marbles calacatta

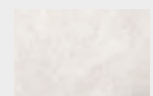

Litos ártico

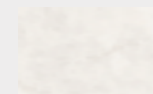

Ópera ivory



Ardenas cromo

Piscinas residenciales: color del agua de las piscinas.

Residential pools: color of pool water. Piscines résidentielles : couleur de l'eau de piscine.

Жилые бассейны: цвет воды в бассейне.



AGUA COLOR TURQUESA CLARO:
LIGHT TURQUOISE WATER:
EAU TURQUOISE CLAIRE :
ПРОЗРАЧНАЯ БИРЮЗОВАЯ ВОДА:

Estas tonalidades tropicales las proporcionan los recubrimientos en tonos arena, beige o tierra claros, son los más adecuados ya que reproducen un efecto parecido al de las playas caribeñas.

These tropical tones are provided by coatings in sand, beige or earth tones, which are the most suitable since they reproduce an effect similar to that of Caribbean beaches.

Ces nuances tropicales sont fournies par des revêtements dans les tons sable, beige ou terre, qui sont les plus adaptés car ils reproduisent un effet similaire à celui des plages des Caraïbes.

Эти тропические оттенки обеспечиваются покрытиями песочных, бежевых или земляных тонов, которые являются наиболее подходящими, поскольку воспроизводят эффект, схожий с эффектом карибских пляжей.



Ópera light



Imperial siena



AGUA COLOR AZUL OCEANO:
OCEAN BLUE COLOUR WATER:
COULEUR BLEU OCEAN EAU:
ВОДА ЦИБЕТА OCEAN BLUE:

Los tonos y sombras grises hacen que el agua de la piscina se vea similar a la del mar, imitando lagos idílicos o incluso el océano en su versión más paradisíaca.

The grey tones and shades make the water in the pool look similar to that of the sea, imitating idyllic lakes or even the ocean in its most paradisiacal version.

Les tons et nuances de gris font ressembler l'eau de la piscine à celle de la mer, imitant les lacs idylliques ou même l'océan dans sa version la plus paradisiaque.

Серые тона и оттенки делают воду в бассейне похожей на морскую, имитируя идиллические озера или даже океан в его самом райском варианте.



Ópera silver



Ardenas gris



Venatto perla



AGUA EN COLOR AZUL TURQUESA FUERTE:
STRONG TURQUOISE BLUE WATER:
EAU BLEU TURQUOISE INTENSE :
СИЛЬНАЯ БИРЮЗОВО-ГОЛУБАЯ ВОДА:

Los tonos beige o marrones más oscuros de las piezas hacen que el agua de la piscina se vea como un azul turquesa pero más intenso.

The darker beige or brown tones of the pieces make the water in the pool look like a turquoise blue but more intense.

Les tons beige ou marron plus foncés des pièces font ressembler l'eau de la piscine à un bleu turquoise mais plus intense.

Темно-бежевые или коричневые тона изделий делают воду в бассейне похожей на бирюзово-голубую, но более насыщенную.



Marbles travertino



Litos sabana

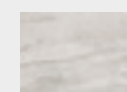

Imperial arian



Nubia



AGUA EN TONOS OSCUROS CON EFECTO ESPEJO:
WATER IN DARK TONES WITH MIRROR EFFECT:
EAU DANS LES TONS FONCÉS AVEC EFFET MIROIR :
ВОДА ТЕМНЫХ ТОНОВ С ЗЕРКАЛЬНЫМ ЭФФЕКТОМ:

Dependiendo del tono de la cerámica, si son tonos cálidos, beige o arena el agua tenderá a gris oscuro verdoso y si son tonos grises tenderá a gris oscuro azulado.

Depending on the tone of the ceramic, if they are warm tones, beige or sand, the water will tend to a dark greenish grey and if they are grey tones it will tend to a dark bluish grey.

En fonction de la tonalité de la céramique, s'il s'agit de tons chauds, beige ou sable, l'eau tendra vers un gris verdâtre foncé et s'il s'agit de tons gris, elle tendra vers un gris bleuté foncé.

В зависимости от тона керамики, если это теплые тона, бежевые или песочные, вода будет иметь тенденцию к темному зеленовато-серому цвету, а если это серые тона, то к темному голубовато-серому.

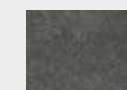

Ardenas antracita



Ópera iron



Imperial ceniza



Recomendaciones de colocación y limpieza.

Recommendations for installation and cleaning. Recommandations pour l'installation et le nettoyage. Рекомендации по установке и очистке.

RECOMENDACIONES DE COLOCACIÓN

Las Series de EXAGRES, S.A. están fabricadas en gres extruido de baja absorción de agua, bajo la norma de producto UNE-EN 14411 Grupo Alb, y también en gres porcelánico prensado, bajo la norma de producto UNE-EN 14411 Grupo Bla. Aunque el dorso de las piezas está estriado en cola de milano para aumentar la adhesión de las mismas al mortero de agarre, EXAGRES recomienda, sin excluir otros posibles métodos, la colocación de baldosas y piezas especiales con mortero adhesivo predosificado (tipo cemento-cola) de buena calidad adecuado al uso y condiciones de uso del recubrimiento cerámico.

En zona de climatología severa, riesgo de heladas o colocación en exteriores o piscinas, se recomienda utilizar morteros adhesivos "tipo flexible", "especial porcelánico", "especial fachadas" o "especial piscinas" en cada caso, de un fabricante reconocido de materiales de instalación de cerámica, disponible en almacenes de materiales. Exagres recomienda seguir las Reglas generales para la ejecución de revestimientos con baldosas cerámicas por adherencia definidos en la norma UNE 138002:2017.

SOPORTE DE COLOCACIÓN

Deberá ser estable dimensionalmente, sano, sólido, resistente y rígido, con superficie de rugosidad suficiente. Soportes flexibles o estructuras deformables requieren una capa de desolidarización y juntas de movimiento, formatos menores y juntas de colocación más anchas.

COLOCACIÓN EN CAPA GRUESA

En caso de utilizar el sistema tradicional, recomendamos usar morteros de capa gruesa mejorados con aditivo látex para aumentar la adhesión de la capa de agarre con la cerámica de baja absorción. Existen morteros adhesivos preparados de capa media que permiten nivelar (hasta 2-3 cm.) e instalar la cerámica a la vez.

COLOCACIÓN EN CAPA FINA

Previamente hay que regularizar el soporte con una capa de mortero de nivelación. Sobre el soporte nivelado se extiende el mortero adhesivo en capa fina (TIPO C2 según norma UNE EN 12004:01), en lecho continuo, con llana dentada de tamaño adecuado. En solados exteriores se resolverán cuidadosamente las pendientes de desagüe, la impermeabilización del soporte y la confección de juntas perimetrales y juntas de partición cada 5x5 m. como máximo. La junta entre las piezas recomendada será de 5mm, para garantizar el buen comportamiento del sistema cerámico, para respetar la modularidad de las series y la correspondencia de juntas entre los diferentes formatos y/o piezas especiales.

IMPORTANTE: se respetará la dirección del ranurado posterior de las baldosas, colocándolas siempre en la misma dirección.

REJUNTADO

El rejuntado se efectuará con un material de prestaciones adecuadas a la solicitud del recubrimiento durante su uso, y se optará por un mortero preparado de cualquier fabricante reconocido, ya que ofrecen una amplia gama de colores y materiales de diferentes características. El tipo de mortero de juntas adecuado será Tipo CG2 (según UNE EN 13888) usando , en caso de requerir resistencia química materiales Tipo RG.

ASESORAMIENTO

Es conveniente contar con el asesoramiento del fabricante de materiales de instalación elegido, para que facilite información sobre prestaciones, instrucciones de uso, tiempo abierto, etc. así como procedimientos de limpieza de la instalación después de la colocación y el rejuntado.

TAREAS PREVIAS A LA COLOCACIÓN

Las baldosas se mezclarán antes de su colocación para conseguir una destonificación armónica, abriendo varias cajas de diferentes pallets, en su caso. Comprobar que la superficie que recibirá el material cerámico, se encuentra libre de restos de otros materiales como residuos de cemento o similar, gravas, arena, etc.

LIMPIEZA DE OBRA Y MANTENIMIENTO

Si después de la colocación y la primera limpieza, quedan restos de materiales cementosos sobre la superficie de la instalación, usar un limpiador cerámico o desincrustante ácido adecuado adquirido en cualquier almacén de materiales. Antes de la aplicación mojar el recubrimiento para saturar las juntas de agua y protegerlas de la acción del limpiador. Después del lavado, eliminar el producto con abundante agua limpia. Para el mantenimiento ordinario, existen productos idóneos específicos para cerámica. En caso de emplear métodos complementarios de limpieza mediante cepillos o almohadillas, no utilizar en ningún caso este tipo de elementos abrasivos de distinta naturaleza.

Desde Exagres, recomendamos el uso de productos de limpieza Fila.



PAVIMENTOS EXTERIORES

Los pavimentos exteriores se encuentran sometidos continuamente a duras condiciones atmosféricas y a la acción de heladas y choque térmicos, que pueden provocar daños irreparables en la instalación. Por ello se extremará el control de ejecución y la calidad de los materiales empleados.

Se asegurará la estanqueidad de la instalación para evitar filtraciones de agua al soporte y se resolverá cuidadosamente el sellado de las juntas, entre piezas, perimetrales y de dilatación. Las juntas de dilatación y partición atravesarán el solado, la capa de agarre y la de nivelación.

RECLAMACIONES

La legislación actual requiere que las demandas sean presentadas antes de la colocación de las baldosas. De modo que no se considerarán reclamaciones sobre materiales ya colocados.

INSTALLATION SUGGESTIONS

EXAGRES, S.A. Series is a glazed and very low water absorption extruded ceramic, product norm EN 14411 Alb Group. Although the back tiles profiled in dove tail to increase the adherence to the setting mortar, EXAGRES recommend, without excluding any other possible systems, installing the tiles and special pieces with a thin set mortar method.

In outdoor places with a hard cold weather, risk of freeze or when placing in exterior wall, the use of "flexible thin set mortar" is recommended, "special porcelanic tile" or "high strength mortar" from a known manufacturer of ceramic tile installation materials, available in any building materials warehouse or tiles dealer.

INSTALLATION SLAB

Must be clean, dry, structurally sound and ensure the rough surface.

A cleavage membrane is necessary in concrete slabs with a deflection and building structures with a movement. Small sizes tiles, wide joints between tiles and movement joints are recommended.

THICK BED METHOD

In that case, use cement mortars with latex admix, for improved bond to the very low absorption tiles.

You can use medium thickness bed mortars for leveling and installing.

THIN BED METHOD

The installation system, over clean, dry structurally sound and free from any bond breaking surface, consist in placing a thin bond coat (C2 Type EN 12004:01 norm), extended continuously with notched trowel. In exteriors the water draining slopes will be carefully resolved, as well the waterproofing slab and the placing perimeter joints and expansion joints every 5x5 m.

The recommended joint between pieces will be 5 mm, to respect modularity and the correspondance of joints between different sizes and/or specials pieces. VERY IMPORTANT we recommend setting the pieces with the back grooved in the same direction.

GROUTING

The grouting will be done by a grout that adequates its characteristics to the coating and the use of installation, choosing any grout from any known manufacturer, whose range of colours and materials are usually wider. Grout must be CG2 Type (EN 13888 norm) using grout RG Type (epoxy grout) for best chemical and stain resistance.

TECHNICAL SUPPORT

It is recommended to be advice by the chosen manufacturer in order to be technical supported about characteristics, instructions of use, open time, etc. as well as cleaning tips after installing tiles.

PREVIOUS TASKS BEFORE INSTALLATION

Before laying the tiles, mix them from several boxes and pallets, in order to ensure a uniform look and the best result.

CLEANING AND MAINTENANCE

If, after installation and initial cleaning, any cementitious material remains on the surface of the installation, use a suitable ceramic cleaner or acid descaler available at any materials store. Before application, wet the coating to saturate the joints with water and protect them from the action of the cleaner. After washing, remove the product with plenty of clean water. For ordinary maintenance, there are specific products suitable for ceramics. In the case of using complementary cleaning methods using brushes or pads, do not use these types of abrasive elements of a different nature under any circumstances.

At Exagres, we recommend the use of Fila cleaning products.



EXTERIORS FLOORS

Exterior floors are submitted to several requirements and weather conditions, frost, thermal shocks, etc. which are able to cause damages.

It is essential to check the masonry works, installation method and quality of tiling materials.

Appropriate slopes, waterproofing, expansion and perimeter joints, grouting and sealing the joints, are fundamental.

COMPLAINTS

Note that current legislation requires disputes to be before installation tiles. Complaints concerning already laid materials shall not, therefore, be proposed and shall not be considered.



Recomendaciones de colocación y limpieza.

Recommendations for installation and cleaning. Recommandations pour l'installation et le nettoyage. Рекомендации по установке и очистке.

RECOMMANDATIONS POUR LA POSE

Les séries d'EXAGRES S.A. ont été fabriquées en gres étiré. Ce carreaux ont une absorption d'eau basse selon la norme EN 14411 Groupe Alb. Bien que la queue d'aronde du dos des carreaux serve à mieux les adhérer au mortier, Exagres conseille de placer les carreaux et pièces spéciales à l'aide d'un mortier adhésif prédosé (genre ciment-colle) de bonne qualité et approprié aux possibles domaines d'application des carreaux.

SUPPORT

Le support doit être solide, résistant, rigide et suffisamment rugueux. Les supports souples ou les structures déformables ont besoin d'une couche de désolidaritation; des joints de mouvement, des formats plus petits, ainsi que des joints plus larges.

POSE EN COUCHE ÉPAISSE

En ce qui concerne le système traditionnel, nous recommandons l'utilisation de mortiers à couche épaisse améliorés à base d'additif latex afin d'augmenter l'adhésion de la couche d'adhérence avec la ceramique à absorption basse. Il existe des mortiers adhésifs à couche moyenne déjà préparés qui permettent de niveler (jusqu'à 2-3 cm) et installer les carreaux au même temps.

POSE EN COUCHE MINCE

Premièrement il faut régulariser le support à l'aide d'une couche de mortier de nivellement. Sur le support nivelé il faut étendre le mortier adhésif en couche mince (TYPE C2 selon UNE EN 12004 :01) et continueuse avec une truelle dentée. Quant aux surfaces extérieures il faut faire attention aux pentes de drainage, à l'imperméabilisation du support. Nous recommandons faire des joints de dilatation tous les 5x5 m au maximum. Les joints entre les carreaux doivent avoir une largeur de 5 mm afin de respecter la modularité des différentes séries.

ATTENTION: il est conseillé de poser les carreaux de façon à ce que la queue d'aronde suive toujours la même direction.

JOINTOLEMENT

Il est conseillé d'effectuer le jointolement avec du matériel approprié au domaine possible d'application des carreaux, en choisissant un mortier d'un fabricant spécialisé, puisqu'ils offrent un grand choix de couleurs et matériaux. Le mortier pour joints le plus approprié est celui de Type CG2 (selon UNE EN 13888). Nous recommandons le matériel du Type RG pour obtenir une résistance aux produits chimiques complémentaires.

SUGGESTION: Il est recommandable de se faire conseiller par le fabricant du matériel choisi par rapport aux caractéristiques, mode d'emploi, temps d'ouverture. Également il peut vous conseiller sur le nettoyage du sol après la pose des carreaux.

RECOMMANDATIONS AVANT LA POSE

Pour que la surface totale de carrelage ait une détonification harmonique, nous conseillons de mélanger des carreaux de différentes boîtes.

NETTOYAGE ET ENTRETIEN

Dans le cas où il resterait des traits de mortier sur la surface d'installation, il faudrait utiliser un produit spécifique pour la céramique ou, autrement, un produit désincrustant. Premièrement il est conseillé de mouiller la surface à nettoyer avec l'objectif de remplir les joints d'eau et les protéger de l'action du produit nettoyant. Une fois le nettoyant appliqué, il faut rincer avec d'eau propre.

Pour ce qui concerne l'entretien ordinaire, il existe des produits spécifiques pour la céramique. En cas d'utilisation de méthodes de nettoyage complémentaires utilisant des brosses ou des tampons, n'utilisez en aucun cas ces types d'éléments abrasifs de nature différente.

Exagres recommande l'utilisation des produits de nettoyage Fila.



REVÊTEMENTS À L'EXTÉRIEUR

Les carreaux posés à l'extérieur peuvent souffrir les effets des chocs thermiques, des gelées, etc, ce qui peut endommager l'installation. De ce fait il faut absolument faire attention aux travaux de pose du carrelage, ainsi qu'à la qualité des matériaux y utilisés. Il faut éviter les filtrations d'eau dans le support. Il faut également faire attention à bien sceller tous les joints.

RÉCLAMATIONS

Selon la loi actuelle aucune réclamation ne sera prise en compte après la pose des carreaux céramiques. Une fois les carreaux placés, les réclamations ne seront pas prises en compte.

РЕКОМЕНДАЦИИ ПО УКЛАДКЕ КЕРАМИЧЕСКО Й ПЛИТКИ И СПЕЦИАЛЬНЫХ ЭЛЕМЕНТОВ EXAGRES

Все коллекции фабрики EXAGRES, S.A. произведены по технологии экструдированного клинкера. Керамическая плитка и элементы EXAGRES имеют низкое водопоглощение в соответствии с нормативом EN 14411 Группа Alb.

ОБЩИЕ РЕКОМЕНДАЦИИ

Технология подготовки оснований и укладки керамической плитки, а также специальных элементов должна соответствовать строительным правилам и нормам вашего региона.

При использовании материалов необходимо тщательно следовать рекомендациям и правилам применения Производителей данных материалов

НАПОЛЬНАЯ ПЛИТКА ДЛЯ НАРУЖНОГО ПРИМЕНЕНИЯ

Внешние покрытия всегда подвергаются воздействию погодных условий, мороза, перепадов температуры, что может послужить причиной деформации укладки. Поэтому, рекомендуем Вам контролировать процесс укладки и качество используемых материалов и растворов.

Основание должно быть должным образом усилено арматурой и гидроизолировано, чтобы избежать протечек воды.

Рекомендуется хорошо заполнять швы между плитками, компенсационные швы и швы по периметру, примыкающие к стенам здания. Компенсационные швы должны полностью пересекать все основание.

ОСНОВАНИЕ, НА КОТОРУЮ БУДЕТ УКЛАДЫВАТЬСЯ ПЛИТКА

Основание, на которую будет укладываться плитка должна быть идеально ровное, прочное, устойчивое и твердое. Поверхность основания должна быть достаточно шероховатой.

При необходимости, при наружных работах, основание должно быть гидроизолировано.

Плитка и ступени на наружных площадках и лестницах должны быть уложены под определенным углом, для избегания застаивания воды

КЛЕЕВЫЕ СМЕСИ

EXAGRES рекомендует, укладывать облицовочную плитку с использованием качественных клеевых цементных смесей, отвечающим требованиям эксплуатации плитки.

Для укладки плитки в бассейнах, в местах с контрастным климатом, а также при наружных работах, рекомендуется использовать профессиональные клеевые смеси, пригодные для реальных условий эксплуатации, например:

- специальный для наружных работ
- специальный для керамогранита
- специальный для фасадов
- специальный для бассейнов
- специальный для клинкера

Клеевые смеси, которые будут использоваться для укладки плитки EXAGRES, должны быть пригодны для приклейки плитки с низким коэффициентом водопоглощения, согласно рекомендациям производителя клеевой смеси

УКЛАДКА В ТОЛСТОМ СЛОЕ

При укладке плитки с одновременным выравниванием основания, а также при толщине плиточного клея до 2-3 см, рекомендуется специальный клей для толстого слоя с латексными добавками.

УКЛАДКА В ТОНКОМ СЛОЕ

Прежде чем наносить слой клея, требуется выровнять основание.

Клеевая смесь наносится зубчатым шпателем на ровное основание тонким слоем

УКЛАДКА ПЛИТКИ

EXAGRES рекомендует перед укладкой плитки и ступеней, вынуть ее из всех коробок и тщательно перемешать между собой, для того чтобы достичь гармоничной разнотонности.

Укладка плитки осуществляется по направлению полос, которые находятся на задней стороне плитки и элементов

КОМПЕНСАЦИОННЫЙ ШОВ РАСШИРЕНИЯ

При укладке плитки на подвижные основания, которые могут деформироваться в процессе эксплуатации требуется предусмотреть компенсационный шов расширения между рядами плитки. Компенсационный шов расширения рекомендуется делать каждые 5x5 м, а также в местах примыкания площадок к стенам зданий. Ширина шва должна быть не меньше 5 мм. Шов расширения должен быть заполнен эластичным наполнителем.

ЗАТИРКА

Затирочный раствор для швов, выбирается в зависимости от условий дальнейшей эксплуатации настеленной поверхности. При укладке снаружи затирка может быть сделана влагостойкой с помощью специальных добавок.

УБОРКА И ОБСЛУЖИВАНИЕ НА ОБЪЕКТЕ

Если после установки и первой очистки на поверхности установки остались остатки цементирующих материалов, используйте подходящее средство для очистки керамики или кислотное средство для удаления накипи, приобретенное в любом магазине материалов. Перед нанесением смочите покрытие, чтобы насытить водой швы и защитить их от действия очистителя. После стирки удалите изделие большим количеством чистой воды. Для обычного ухода существуют подходящие средства специально для керамики. В случае использования дополнительных методов очистки с помощью щеток или подушечек, ни в коем случае не используйте абразивные элементы другой природы.

Exagres рекомендует использовать чистящие средства Fila.



Proceso de extrusión.

Extrusion process. Procédé d'extrusion. Процесс экструзии.

La extrusión es una técnica de conformado para la fabricación de productos cerámicos. Básicamente el proceso de extrusión consiste en forzar el paso, mediante la aplicación de presión, de la pasta con consistencia plástica a través de una matriz. La fabricación de baldosas mediante el proceso de extrusión consta de cuatro fases principales: amasado, conformado, secado y cocción.

- El amasado consiste en el mezclado con agua de las materias primas previamente preparadas y molidas. Con esto se consigue una pasta fácilmente moldeable por extrusión.
- En el conformado se realiza introduciendo la masa plástica en la extrusora, y con presión de vacío es amasada y empujada a través de la boquilla para obtener las piezas finales. Con este proceso se pueden obtener piezas especiales como peldaños o bordes piscinas, etc...
- Después las piezas ya moldeadas son sometidas a aire caliente para eliminar el contenido de humedad.
- Posteriormente son cocidas a altas temperaturas, obteniendo una perfecta vitrificación de las mismas.

Con este proceso los materiales pueden ser reciclados en su totalidad y admiten hasta un 45% de materiales reciclados en su proceso estándar.

Extrusion process is a forming technique for the manufacture of ceramic products. Basically this process consists in forcing the passage, through the application of a pressure, of the paste with a plastic consistency through a matrix.

The manufacture of tiles by the extrusion process entails four main phases: kneaded, shaping, drying and firing.

- The kneading consists in the mixing with water of the raw materials previously prepared and ground. This provides an easily extrudable paste.
- In the shaping stage, the plastic mass using vacuum pressure is kneaded and pushed through the nozzle to make tiles. This process is widely used to make special tiles pieces like steps or swimming pool border tiles, ... etc.
- Once the tiles have been shaped, hot air is used to remove the moisture content.
- Afterwards they are fired to high temperatures, to obtain a perfect vitrification.

With this process, the tiles can be recycled completely and up to 45% recycled materials are accepted in their standard process.

L'extrusion est une technique de mise en forme pour la fabrication de produits en céramique.

Le procédé d'extrusion consiste essentiellement à forcer le passage, à travers l'application d'une pression, de la pâte à consistance plastique à travers une matrice.

La fabrication de carreaux par le procédé d'extrusion se compose de quatre phases principales : malaxage, mise en forme, séchage et cuisson.

- Le malaxage consiste à mélanger avec de l'eau les matières premières qui ont été préalablement préparées et moulues. Grâce à cela, on obtient une pâte que l'on peut facilement mouler par extrusion.
- La mise en forme se réalise en introduisant la pâte plastique dans une machine à extrusion. Cette pâte, sous la pression du vide, est malaxée et poussée à travers une filière pour obtenir les pièces finales. Grâce à ce procédé, il est possible d'obtenir des pièces spéciales comme des marches ou des margelles de piscines, etc.
- Ensuite, les pièces déjà moulées sont passées à l'air chaud afin d'éliminer le contenu d'humidité.
- Puis, elles sont cuites à hautes températures, ce qui permet d'obtenir de ces dernières une parfaite vitrification. Grâce à ce procédé, les matériaux peuvent être recyclés dans leur totalité et permettent jusqu'à 45 % de matériaux recyclés dans leur procédé standard.

Экструзия — технология, используемая для формовки керамических изделий при их изготовлении.

В основном процесс экструзии заключается в продавливании под давлением пастообразного сырья через формирующее отверстие.

Производство керамической плитки с помощью экструзии состоит из четырех основных этапов: замеса, формовки, сушки и обжига.

- Замес заключается в смешивании с водой предварительно подготовленного и измельченного сырья. Конечным результатом этого процесса является легко поддающаяся обработке паста для экструзии.

- Формовка представляет собой загрузку полученной при замесе пасты в экструдер, в котором она перемешивается под вакуумным давлением и проталкивается через сопло для формовки конечных изделий.

С помощью этого процесса можно получить специальные изделия, такие как ступени или бордюры для бассейнов и т. д. После этого, уже сформованные изделия проходят обработку горячим воздухом для удаления влаги.

- Затем они подвергаются высокотемпературному обжигу до достижения ими необходимой витрификации (стеклования). С помощью этого процесса материалы могут быть полностью переработаны. В стандартном процессе допускается использование до 45 % переработанных материалов.

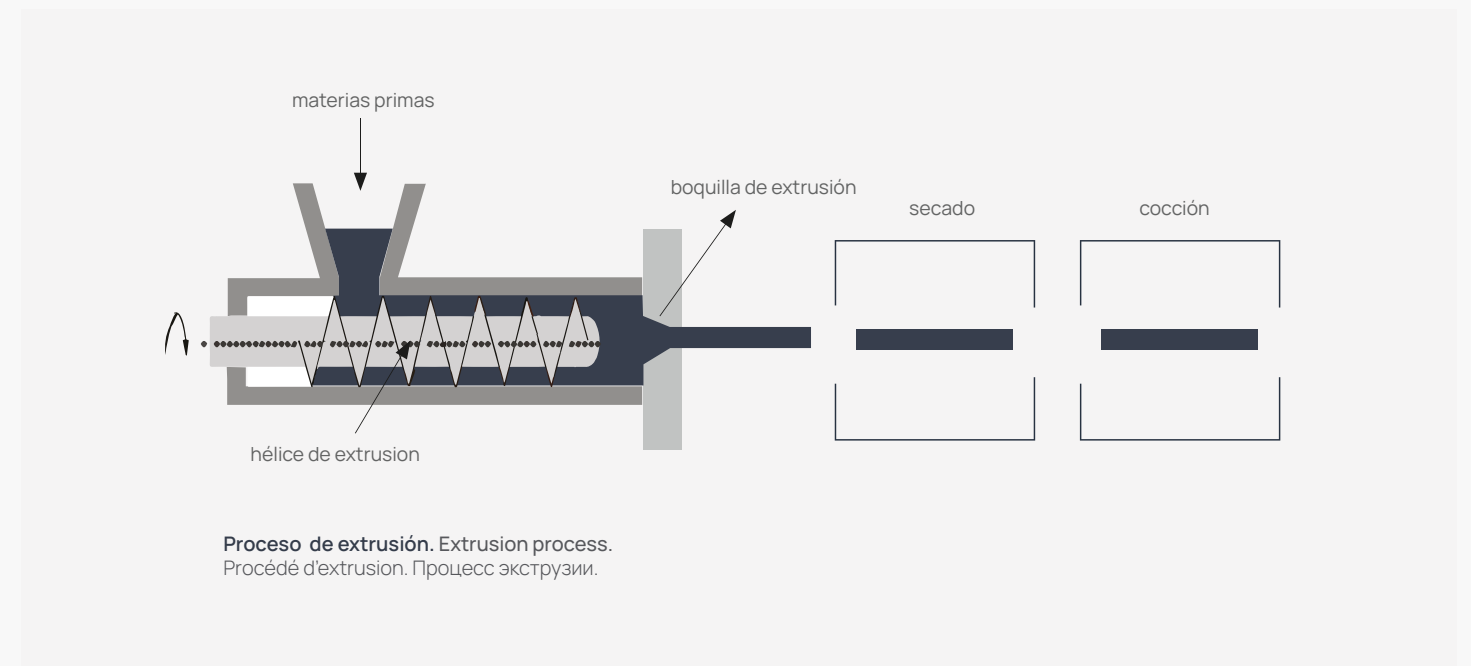

El valor de la extrusión.

Extrusion values. La valeur de l'extrusion. Значение экструзии.

Las materias primas seleccionadas y el cuidado proceso de producción con las tecnologías más avanzadas y la labor de nuestro equipo humano, hacen que el producto obtenido posea unas características técnicas excepcionales.

Además la extrusión dota a las piezas de una microestructura interna homogénea, estable y resistente ante esfuerzos mecánicos. Con este proceso se pueden obtener geometrías tridimensionales en las piezas, imposibles de conseguir con el proceso de prensado tradicional.

The raw materials selected, the careful production process with the most advanced technologies, and the work of our human team mean that the product obtained has exceptional technical characteristics.

In addition, extrusion gives the parts a homogeneous, stable and mechanically resistant internal microstructure.

With this process, three-dimensional geometries can be obtained on the pieces which are impossible to achieve with the traditional compacting process

Les matières premières choisies, le rigoureux procédé de production qui utilise les technologies les plus avancées, ainsi que le travail de notre équipe humaine font que le produit obtenu possède des caractéristiques techniques exceptionnelles.

En outre, l'extrusion confère aux pièces une microstructure interne homogène, stable et mécaniquement résistante.

Grâce à ce procédé, on peut obtenir des géométries tridimensionnelles sur les pièces, impossibles à réaliser avec le procédé de pressage traditionnel.

Благодаря отборному сырью и тщательному процессу производства с использованием самых передовых технологий и работе нашего коллектива полученные изделия обладают исключительными техническими характеристиками.

Кроме того, экструзия придает деталям однородную, стабильную и механически устойчивую внутреннюю микроструктуру.

Этот процесс позволяет изготавливать трехмерные изделия, что невозможно при использовании традиционного процесса прессования.

Características técnicas.

Technical data. Caractéristiques techniques. Технические характеристики.

Gres extruido de pasta blanca de baja absorción de agua, según UNE-EN 14411, grupo Alb, esmaltado.

White body extruded stoneware with low water absorption, according to EN 14411, group Alb, glazed.

Grès blanc extrudé à faible absorption d'eau, selon la norme UNE-EN 14411, groupe Alb, émaillé.

Экструдированный керамогранит белого цвета с низким водопоглощением, согласно UNE-EN 14411, группа Alb, глазурованный.

	Absorción de agua Water absorption Absorption d'eau Водопоглощение	Resistencia a la flexión Modulus of rupture Résistance à la flexion Сопротивление на изгиб	Resistencia a la abrasión (peí) Deep abrasion resistance Résistance à l'abrasion Стойкость к истиранию поверхности	Resistencia al choque térmico Thermal shock resistance Résist. aux variations thermiques Стойкость к тепловым перепадам	Resistencia al cuarteo Cracking resistance Résistance au tressailage Устойчивость к растрескиванию	Resistencia a la helada Frost resistance Résistance au gel Морозостойкость	Resistencia a los agentes químicos Chemical resistance Résistance aux produits chimiques Стойкость к воздействию химикатов	Resistencia a las manchas Stain resistance Résistance aux taches Устойчивость к образованию пятен	Resistencia al deslizamiento (rampa pie calzado) Anti-slip resistance (ramp) Résistance au glissement (pied chaussé) Сопротивление скольжению (если ходит обутым)	Resistencia al deslizamiento (péndulo) anti-slip resistance (pendulum) Résistance au glissement (balancier) Сопротивление скольжению (маятник)	Resistencia al deslizamiento (rampa pie descalzo) Anti-slip resistance (barefoot ramp) Résistance au glissement (rampe pieds nus) Сопротивление скольжению (рампа для босых ног)
COLECCIÓN	ISO 10545-3	ISO 10545-4	ISO 10545-7	ISO 10545-9	ISO 10545-11	ISO 10545-12	ISO 10545-13	ISO 10545-14	EN 16165 Anexo B	EN 16165 Anexo C	EN 16165 Anexo A
IMPERIAL	< 1,5%	> 30 N/mm ² > 1800 N	4	garantizado guaranteed garanti Гарантированно	garantizado guaranteed garanti Гарантированно	garantizado guaranteed garanti Гарантированно	A - LA - HA	CLASE 5	R9 normal R11 anti-slip	CLASE 1 norma CLASE 3 anti-slip	- CLASE C anti-slip
NUBIA	< 1,5%	> 30 N/mm ² > 1800 N	4	garantizado guaranteed garanti Гарантированно	garantizado guaranteed garanti Гарантированно	garantizado guaranteed garanti Гарантированно	A - LA - HA	CLASE 5	R9 normal R11 anti-slip	CLASE 1 normal CLASE 3 anti-slip	- CLASE C anti-slip
VENATTO	< 1,5%	> 30 N/mm ² > 1800 N	4	garantizado guaranteed garanti Гарантированно	garantizado guaranteed garanti Гарантированно	garantizado guaranteed garanti Гарантированно	A - LA - HA	CLASE 5	R9 normal R11 anti-slip	CLASE 1 normal CLASE 3 anti-slip	- CLASE C anti-slip
MARBLES	< 1,5%	> 30 N/mm ² > 1800 N	5	garantizado guaranteed garanti Гарантированно	garantizado guaranteed garanti Гарантированно	garantizado guaranteed garanti Гарантированно	A - LA - HA	CLASE 5	R9 normal R11 anti-slip	CLASE 1 normal CLASE 3 anti-slip	- CLASE C anti-slip
LIZANA	< 1,5%	> 30 N/mm ² > 1800 N	3	garantizado guaranteed garanti Гарантированно	garantizado guaranteed garanti Гарантированно	garantizado guaranteed garanti Гарантированно	A - LA - HA	CLASE 5	R9 normal R12 anti-slip	CLASE 1 normal CLASE 3 anti-slip	- CLASE C anti-slip
YOHO	< 1,5%	> 30 N/mm ² > 1800 N	4	garantizado guaranteed garanti Гарантированно	garantizado guaranteed garanti Гарантированно	garantizado guaranteed garanti Гарантированно	A - LA - HA	CLASE 5	R9 normal R11 anti-slip	CLASE 1 normal CLASE 3 anti-slip	- CLASE C anti-slip
COSMOS	< 1,5%	> 30 N/mm ² > 1800 N	3	garantizado guaranteed garanti Гарантированно	garantizado guaranteed garanti Гарантированно	garantizado guaranteed garanti Гарантированно	A - LA - HA	CLASE 5	R9 normal R11 anti-slip	CLASE 1 normal CLASE 3 anti-slip	- -
ÓPERA	< 1,5%	> 30 N/mm ² > 1800 N	4	garantizado guaranteed garanti Гарантированно	garantizado guaranteed garanti Гарантированно	garantizado guaranteed garanti Гарантированно	A - LA - HA	CLASE 5	R9 normal R12 anti-slip	CLASE 1 normal CLASE 3 anti-slip	CLASE C anti-slip CLASE C anti-slip
MEDITERRÁNEO	< 1,5%	> 30 N/mm ² > 1800 N	2 grafito 4 arena	garantizado guaranteed garanti Гарантированно	garantizado guaranteed garanti Гарантированно	garantizado guaranteed garanti Гарантированно	A - LA - HA	CLASE 5	R9 normal R11 anti-slip	CLASE 1 normal CLASE 3 anti-slip	- -

Características técnicas.

Technical data. Caractéristiques techniques. Технические характеристики.

Gres extruido de pasta blanca de baja absorción de agua, según UNE-EN 14411, grupo Alb, esmaltado.

White body extruded stoneware with low water absorption, according to EN 14411, group Alb, glazed.

Grès blanc extrudé à faible absorption d'eau, selon la norme UNE-EN 14411, groupe Alb, émaillé.

Экструдированный керамогранит белого цвета с низким водопоглощением, согласно UNE-EN 14411, группа Alb, глазурованный.

COLECCIÓN	Absorción de agua Water absorption Absorption d'eau Водопоглощение	Resistencia a la flexión Modulus of rupture Résistance à la flexion Сопротивление на изгиб	Resistencia a la abrasión (peí) Deep abrasion resistance Résistance à l'abrasion Стойкость к истиранию поверхности	Resistencia al choque térmico Thermal shock resistance Résist. aux variations thermiques Стойкость к тепловым перепадам	Resistencia al cuarteo Cracking resistance Résistance au tressailage Устойчивость к растрескиванию	Resistencia a la helada Frost resistance Résistance au gel Морозостойкость	Resistencia a los agentes químicos Chemical resistance Résistance aux produits chimiques Стойкость к воздействию химикатов	Resistencia a las manchas Stain resistance Résistance aux taches Устойчивость к образованию пятен	Resistencia al deslizamiento (rampa pie calzado) Anti-slip resistance (ramp) Résistance au glissement (pied chaussé) Сопротивление скольжению (если ходит обутым)	Resistencia al deslizamiento (péndulo) anti-slip resistance (pendulum) Résistance au glissement (balancier) Сопротивление скольжению (маятник)	Resistencia al deslizamiento (rampa pie descalzo) Anti-slip resistance (barefoot ramp) Résistance au glissement (rampe pieds nus) Сопротивление скольжению (рампа для босых ног)
	ISO 10545-3	ISO 10545-4	ISO 10545-7	ISO 10545-9	ISO 10545-11	ISO 10545-12	ISO 10545-13	ISO 10545-14	EN 16165 Anexo B	EN 16165 Anexo C	EN 16165 Anexo A
BEDFORD	< 1,5%	> 30 N/mm ² > 1800 N	3-4	garantizado guaranteed garanti Гарантированно	garantizado guaranteed garanti Гарантированно	garantizado guaranteed garanti Гарантированно	A - LB - HB	CLASE 5	R9 normal R12 anti-slip	CLASE 1 normal CLASE 3 anti-slip	- CLASE C anti-slip
ARDENAS	< 1,5%	> 30 N/mm ² > 1800 N	4 marfil/cromo/gris 2 antracita	garantizado guaranteed garanti Гарантированно	garantizado guaranteed garanti Гарантированно	garantizado guaranteed garanti Гарантированно	A - LA - HA	CLASE 5	R9 normal R12 anti-slip	CLASE 1 normal CLASE 3 anti-slip	- CLASE C anti-slip
ALBAROC	< 1,5%	> 30 N/mm ² > 1800 N	4 hulla 5 boal/galena	garantizado guaranteed garanti Гарантированно	garantizado guaranteed garanti Гарантированно	garantizado guaranteed garanti Гарантированно	A - LA - HA	CLASE 5	R10 normal R12 anti-slip	CLASE 1 normal CLASE 3 anti-slip	- CLASE C anti-slip
LITOS	< 1,5%	> 30 N/mm ² > 1800 N	4	garantizado guaranteed garanti Гарантированно	garantizado guaranteed garanti Гарантированно	garantizado guaranteed garanti Гарантированно	A - LA - HA	CLASE 5	R9 normal R12 anti-slip	CLASE 1 normal CLASE 3 anti-slip	- CLASE C anti-slip
MANHATTAN	< 1,5%	> 30 N/mm ² > 1300 N	4	garantizado guaranteed garanti Гарантированно	garantizado guaranteed garanti Гарантированно	garantizado guaranteed garanti Гарантированно	A - LA - HA	CLASE 5	R11	CLASE 2	-
VEGA	< 1,5%	> 30 N/mm ² > 1800 N	2 rojo/rojo anti-slip 3 ocre/visón 4 ocre anti-slip/gris 5 gris anti-slip/visón anti-slip	garantizado guaranteed garanti Гарантированно	garantizado guaranteed garanti Гарантированно	garantizado guaranteed garanti Гарантированно	A - LA - HA	CLASE 5	R9 normal R10 anti-slip	CLASE 1 normal CLASE 2 anti-slip	- -
PROVENZA	< 1,5%	> 30 N/mm ² > 1800 N	3-4	garantizado guaranteed garanti Гарантированно	garantizado guaranteed garanti Гарантированно	garantizado guaranteed garanti Гарантированно	A - LB - HB	CLASE 5	R9 normal R12 anti-slip	CLASE 1 normal CLASE 3 anti-slip	- CLASE C anti-slip
PORTLAND	< 1,5%	> 30 N/mm ² > 1800 N	4	garantizado guaranteed garanti Гарантированно	garantizado guaranteed garanti Гарантированно	garantizado guaranteed garanti Гарантированно	A - LB - HB	CLASE 5	R12	CLASE 3	-
ALHAMAR	< 1,5%	> 30 N/mm ² > 1800 N	3 rojo 4 blanco/paja/salmón	garantizado guaranteed garanti Гарантированно	garantizado guaranteed garanti Гарантированно	garantizado guaranteed garanti Гарантированно	A - LA - HA	CLASE 5	R9 normal R12 anti-slip	CLASE 1 normal CLASE 3 anti-slip	- -
METÁLICA	< 1,5%	> 30 N/mm ² > 1800 N	3	garantizado guaranteed garanti Гарантированно	garantizado guaranteed garanti Гарантированно	garantizado guaranteed garanti Гарантированно	A - LB - HB	CLASE 5	R9	CLASE 1	-

Embalaje.

Packing. Emballage. Упаковка.

MARBLE]

IMPERIAL	PIEZAS · PIECES · PIÈCES · ЗАПЧАСТИ	CAJAS · BOXES · BOITES · КОРОБКИ	PALETS · PALLETS · PALLETES · ПАЛЛЕТЫ	MEDIDAS DE FABRICACIÓN · MANUFACTURING MEASURES
Base 120x120 cm - 10 mm	0,69 pcs / m ²	1 pcs. / 34,35 Kg	38 boxes / 1.306 Kg	1198x1198 mm
Base 120x120 cm - 9 mm	0,63 pcs / m ²	1 pcs. / 31,65 Kg	40 boxes / 1.266 Kg	1198x1198 mm
Base 60x120 cm - 10 mm	1,39 pcs / m ²	2 pcs. / 34,50 Kg	27 boxes / 932 Kg	598x1198 mm
Base 60x120 cm - 9,2 mm	1,39 pcs / m ²	2 pcs. / 29,80 Kg	33 boxes / 983 Kg	598x1198 mm
Base 14,5x120 cm - 9,2 mm	5,75 pcs / m ²	4 pcs. / 18,48 Kg	64 boxes / 1.183 Kg	145x1198 mm
Base 60x60 cm - 10,3 mm	2,77 pcs / m ²	4 pcs. / 32 Kg	30 boxes / 960 Kg	-
Base 60x60 cm - 9,4 mm	2,77 pcs / m ²	3 pcs. / 23,40 Kg	40 boxes / 936 Kg	596x596 mm
Base 33x66,5 cm - 10 mm	4,56 pcs. / m ²	5 pcs. / 24,25 Kg	40 boxes / 970 Kg	-
Peldaño recto 120 33x120x3 cm - 12 mm	0,83 pcs / ml	2 pcs. / 24,40 Kg	11 boxes / 268 Kg	-
Remate peldaño recto 3 x 33 cm	-	20 pcs. / 3,20 Kg	92 boxes / 295 Kg	-
Zanquín ingletado recto* 59,6 x 59,6 cm - 11 mm	-	9 pcs. / 19,80 Kg	56 boxes / 1.109 Kg	-
Peldaño ML 120 33x120x4 cm - 13 mm	0,83 pcs. / ml	2 pcs. / 28 Kg	10 boxes / 280 Kg	-
Remate ML izda./dcha. 4x33 cm	-	20 pcs. / 3,20 Kg	92 boxes / 295 Kg	-
Zanquín ingletado ML izda/dcha* 59,6 x 59,6 cm - 11 mm	-	9 pcs. / 19,80 Kg	56 boxes / 1.109 Kg	-
Rodapié 9x60 cm - 11 mm	1,66 pcs / ml	18 pcs. / 19,80 Kg	56 boxes / 1.109 Kg	-
Borde skimmer 45x75x3 cm - 30mm	1,33 pcs. / ml	2 pcs. / 30 Kg	29 boxes / 870 Kg	445x750x30mm
Borde desbordante 28x66,5 cm - 30 mm	1,50 pcs. / ml	2 pcs. / 14,47 Kg	72 boxes / 1042 Kg	-
Ángulo desbordante 31x31 cm - 30 mm	-	1 pcs. / 4,01 Kg	92 boxes / 369 Kg	-
Rejilla 24,5x24,5 cm - 30 mm	4 pcs. / ml	6 pcs. / 15,78 Kg	57 boxes / 900 Kg	-
Ángulo rejilla izda/dcha.* 33x33 cm - 30 mm	-	1 pcs. / 4,50 Kg	82 boxes / 369 Kg	-
Media caña 4 - 4,2x33 cm	3 pcs. / ml	52 pcs. / 13 Kg	64 boxes / 832 Kg	4,2x33
Uña media caña 4 - 4,2x4,2 cm	-	4 pcs. / 0,40 Kg	200 boxes / 80 Kg	4,2x4,2
Arista 3 - 3,3x33 cm	3 pcs. / ml	70 pcs. / 11,90 Kg	64 boxes / 762 Kg	3,3x33
Uña arista 3 - 3,3x3,3 cm	-	4 pcs. / 0,40 Kg	200 boxes / 80 Kg	3,3x3,3
Ángulo arista 3 - 3,3x4,2x5 cm	-	8 pcs. / 0,43 Kg	200 boxes / 86 Kg	-
Ángulo media caña 4 - 4,3x3,3x5 cm	-	8 pcs. / 0,43 Kg	200 boxes / 86 Kg	-

NUBIA	PIEZAS · PIECES · PIÈCES · ЗАПЧАСТИ	CAJAS · BOXES · BOITES · КОРОБКИ	PALETS · PALLETS · PALLETES · ПАЛЛЕТЫ	MEDIDAS DE FABRICACIÓN · MANUFACTURING MEASURES
Base 60x120 cm - 10 mm	1,39 pcs / m ²	2 pcs. / 30 Kg	35 boxes / 1.050 Kg	-
Base 33x66,5 cm - 10 mm	4,50 pcs. / m ²	5 pcs. / 25,38 Kg	40 boxes / 1.015 Kg	-
Peldaño recto 120 33x120x4 cm - 12 mm	0,83 pcs / ml	2 pcs. / 24,40 Kg	11 boxes / 268 Kg	-
Media caña 4 - 4,2x33 cm	3 pcs / ml	52 pcs. / 13 Kg	64 boxes / 832 Kg	4,2x33
Uña media caña 4 - 4,2x4,2 cm	-	4 pcs. / 0,40 Kg	200 boxes / 80 Kg	4,2x4,2
Arista 3 - 3,3x33 cm	3 pcs / ml	70 pcs. / 11,90 Kg	64 boxes / 762 Kg	3,3x33
Uña arista 3 - 3,3x3,3 cm	-	4 pcs. / 0,40 Kg	200 boxes / 80 Kg	3,3x3,3

* Set de dos piezas / Set of two tiles / Set de deux pièces / Набор из двух штук.

VENATTO	PIEZAS · PIECES · PIÈCES · ЗАПЧАСТИ	CAJAS · BOXES · BOITES · КОРОБКИ	PALETS · PALLETS · PALLETES · ПАЛЛЕТЫ	MEDIDAS DE FABRICACIÓN · MANUFACTURING MEASURES
Base 120x120 cm - 10 mm	0,69 pcs / m ²	1 pcs. / 34,35 Kg	38 boxes / 1.306 Kg	1198x1198 mm
Base 60x120 cm - 10 mm	1,39 pcs / m ²	2 pcs. / 34,50 Kg	27 boxes / 932 Kg	598x1198 mm
Base 14,5x120 cm - 10 mm	5,75 pcs / m ²	4 pcs. / 18,48 Kg	64 boxes / 1.183 Kg	145x1198 mm
Base 33x66,5 cm - 10 mm	4,50 pcs. / m ²	5 pcs. / 25 Kg	40 boxes / 1.000 Kg	-
Peldaño ML 120 33x120x4 cm - 13 mm	0,83 pcs. / m ²	2 pcs. / 24,40 Kg	10 boxes / 244 Kg	-
Remate ML izda./dcha. 4x33 cm	-	20 pcs. / 3,20 Kg	92 boxes / 295 Kg	-
Zanquín ingletado ML izda/dcha* 59,6 x 59,6 cm - 11 mm	-	9 pcs. / 19,80 Kg	56 boxes / 1.109 Kg	-
Rodapié 9x60 cm - 11 mm	1,66 pcs / ml	18 pcs. / 19,80 Kg	56 boxes / 1.109 Kg	-
Borde skimmer 45x75x3 cm - 30 mm	1,33 pcs. / ml	2 pcs. / 30 Kg	29 boxes / 870 Kg	445x750x30mm
Borde desbordante 28x66,5 cm - 30 mm	1,50 pcs. / ml	2 pcs. / 14,47 Kg	72 boxes / 1042 Kg	-
Ángulo desbordante 31x31 cm - 30 mm	-	1 pcs. / 4,01 Kg	92 boxes / 369 Kg	-
Rejilla 24,5x24,5 cm - 30 mm	4 pcs. / ml	6 pcs. / 15,78 Kg	57 boxes / 900 Kg	-
Ángulo rejilla izda/dcha* 33x33 cm - 30 mm	-	1 pcs. / 4,50 Kg	82 boxes / 369 Kg	-
Media caña 4 - 4,2x33 cm	3 pcs. / ml	52 pcs. / 13 Kg	64 boxes / 832 Kg	4,2x33
Uña media caña 4 - 4,2x4,2 cm	-	4 pcs. / 0,40 Kg	200 boxes / 80 Kg	4,2x4,2
Arista 3 - 3,3x33 cm	3 pcs. / ml	70 pcs. / 11,90 Kg	64 boxes / 762 Kg	3,3x33
Uña arista 3 - 3,3x3,3 cm	-	4 pcs. / 0,40 Kg	200 boxes / 80 Kg	3,3x3,3
Ángulo arista 3 - 3,3x4,2x5 cm	-	8 pcs. / 0,43 Kg	200 boxes / 86 Kg	-
Ángulo media caña 4 - 4,3x3,3x5 cm	-	8 pcs. / 0,43 Kg	200 boxes / 86Kg	-

MARBLES	PIEZAS · PIECES · PIÈCES · ЗАПЧАСТИ	CAJAS · BOXES · BOITES · КОРОБКИ	PALETS · PALLETS · PALLETES · ПАЛЛЕТЫ	MEDIDAS DE FABRICACIÓN · MANUFACTURING MEASURES
Base 60x120 cm - 9 mm	1,39 pcs / m ²	2 pcs. / 29,40 Kg	36 boxes / 1.058 Kg	-
Base 14,5x120 cm - 10 mm	5,75 pcs / m ²	4 pcs. / 18,48 Kg	64 boxes / 1.100 Kg	-
Base 33x66,5 cm - 10 mm	4,50 pcs. / m ²	5 pcs. / 25,38 Kg	40 boxes / 1.015 Kg	-
Peldaño recto 120 33x120x3 cm - 12 mm	0,83 pcs / ml	2 pcs. / 25,90 Kg	11 boxes / 285 Kg	-
Peldaño fiorentino 120 33x120x3 cm - 12 mm	0,83 pcs / ml	2 pcs. / 25,90 Kg	11 boxes / 285 Kg	-
Peldaño recto 60 33x60x3 cm - 12 mm	1,66 pcs / ml	2 pcs. / 11,70 Kg	20 boxes / 234 Kg	-
Remate peldaño recto 3 x 33 cm	-	20 pcs. / 3,20 Kg	92 boxes / 294 Kg	-
Remate peldaño fiorentino izda./dcha. 3 x 33 cm	-	20 pcs. / 3,20 Kg	92 boxes / 294 Kg	-
Zanquín recto 18x40 cm - 15 mm	-	6 pcs. / 15 Kg	66 boxes / 990 Kg	-
Zanquín fiorentino izda/dcha 18x40 cm - 15 mm	-	6 pcs. / 15 Kg	66 boxes / 990 Kg	-
Media caña 4 - 4,2x33 cm	3 pcs / ml	52 pcs. / 13 Kg	64 boxes / 832 Kg	4,2x33
Uña media caña 4 - 4,2x4,2 cm	-	4 pcs. / 0,40 Kg	200 boxes / 80 Kg	4,2x4,2
Arista 3 - 3,3x33 cm	3 pcs / ml	70 pcs. / 11,90 Kg	64 boxes / 762 Kg	3,3x33
Uña arista 3 - 3,3x3,3 cm	-	4 pcs. / 0,40 Kg	200 boxes / 80 Kg	3,3x3,3
Rodapié 9x40 cm - 15 mm	2,50 pcs / ml	12 pcs. / 15 Kg	66 boxes / 990 Kg	-

* Set de dos piezas / Set of two tiles / Set de deux pièces / Набор из двух штук.

Embalaje.

Packing. Emballage. Упаковка.

WOOD]

LIZANA	PIEZAS · PIECES · PIÈCES · ЗАПЧАСТИ	CAJAS · BOXES · BOITES · КОРОБКИ	PALETS · PALLETS · PALLETES · ПАЛЛЕТЫ	MEDIDAS DE FABRICACIÓN · MANUFACTURING MEASURES
Base 25x150 cm - 9 mm	2,66 pcs / m ²	3 pcs. / 23,80 Kg	56 boxes / 1.333 Kg	-
Base 25x150 cm - 9 mm	2,66 pcs / m ²	3 pcs. / 24,07 Kg	54 boxes / 1.300 Kg	-
Base 20x120 cm - 11 mm	4,17 pcs / m ²	4 pcs. / 24,20 Kg	51 boxes / 1.235 Kg	203x1200 mm
Base 14,5x120 cm - 9 mm	5,75 pcs / m ²	4 pcs. / 18,48 Kg	64 boxes / 1183 Kg	-
Base 16,25x66,5 cm - 10 mm	9 pcs. / m ²	10 pcs. / 25,30 Kg	40 boxes / 1.012 Kg	-
Peldaño recto 120 33x120x3 cm - 12 mm	0,83 pcs / ml	2 pcs. / 25,90 Kg	11 boxes / 285 Kg	-
Peldaño ML 150 33 x 150 x 4 cm - 13 mm	-	2 pcs. / 32,20 Kg	10 boxes / 322 Kg	-
Remate peldaño recto 3 x 33 cm	-	20 pcs. / 3,20 Kg	92 boxes / 295 Kg	-
Remate peldaño ML izda/dcha 4x33 cm	-	20 pcs. / 3,20 Kg	92 boxes / 295 Kg	-
Rodapié 9x60 cm - 11 mm	1,66 pcs / ml	18 pcs. / 19,80 Kg	56 boxes / 1.109 Kg	-
Zanquín ingletado recto* 59,6 x 59,6 cm - 11 mm	-	9 pcs. / 19,80 Kg	56 boxes / 1.110 Kg	-
Zanquín ingletado ML izda/dcha* 59,6 x 59,6 cm - 11 mm	-	9 pcs. / 19,80 Kg	56 boxes / 1.110 Kg	-
Borde desbordante 28x66,5 cm - 30 mm	1,50 pcs. / ml	2 pcs. / 14,46 Kg	72 boxes / 1042 Kg	-
Rejilla 24,5x66,5 cm - 30 mm	1,50 pcs / ml	3 pcs. / 21,90 Kg	36 boxes / 788 Kg	-
Ángulo desbordante 31x31 cm - 30 mm	-	1 pcs. / 4,01 Kg	92 boxes / 369 Kg	-
Ángulo rejilla izda/dcha* 33x33 cm - 30 mm	-	1 pcs. / 4,5 Kg	82 boxes / 369 Kg	-

YOHO	PIEZAS · PIECES · PIÈCES · ЗАПЧАСТИ	CAJAS · BOXES · BOITES · КОРОБКИ	PALETS · PALLETS · PALLETES · ПАЛЛЕТЫ	MEDIDAS DE FABRICACIÓN · MANUFACTURING MEASURES
Base 24,5x150 - 11 mm	2,72 pcs / m ²	3 pcs. / 29,25 Kg	42 boxes / 1.230 Kg	-
Base 25x150 cm - 9 mm	2,66 pcs / m ²	3 pcs. / 24,42 Kg	54 boxes / 1.360 Kg	-
Base 25x150 cm - 9 mm	2,66 pcs / m ²	3 pcs. / 23,80 Kg	56 boxes / 1.333 Kg	-
Base 14,5x120 cm - 10,1 mm	5,75 pcs / m ²	4 pcs. / 18,48 Kg	64 boxes / 1.195 Kg	-
Base 14,5x120 cm - 9 mm	5,75 pcs / m ²	4 pcs. / 18,48 Kg	64 boxes / 1.183 Kg	-
Base 16,25x66,5 cm - 10 mm	9 pcs. / m ²	10 pcs. / 25,30 Kg	40 boxes / 1.012 Kg	-
Peldaño recto 120 33x120x3 cm - 12 mm	0,83 pcs / ml	2 pcs. / 24,90 Kg	11 boxes / 274 Kg	-
Remate peldaño recto 3 x 33 cm	-	20 pcs. / 3,20 Kg	92 boxes / 294 Kg	-
Zanquín recto izda/dcha 17,5x42,3 cm (maple) - 7,5 mm	-	14 pcs. / 10 Kg	54 boxes / 540 Kg	-
Zanquín ingletado recto* 59,6 x 59,6 cm (natural / oak / teca) - 11 mm	-	9 pcs. / 19,80 Kg	56 boxes / 1.110 Kg	-
Rodapié 9x60 cm - 11 mm	1,66 pcs / ml	18 pcs. / 19,80 Kg	56 boxes / 1.109 Kg	-
Borde skimmer 45x75x3 - 30mm	1,33 pcs. / ml	2 pcs. / 30 Kg	29 boxes / 870 Kg	445x750x30mm

URBAN]

COSMOS	PIEZAS · PIECES · PIÈCES · ЗАПЧАСТИ	CAJAS · BOXES · BOITES · КОРОБКИ	PALETS · PALLETS · PALLETES · ПАЛЛЕТЫ	MEDIDAS DE FABRICACIÓN · MANUFACTURING MEASURES
Base 120x120 cm - 11 mm	0,69 pcs / m ²	1 pcs. / 36,13 Kg	38 boxes / 1.373 Kg	-
Base 60x120 cm - 9 mm	1,39 pcs / m ²	2 pcs. / 28,70 Kg	36 boxes / 1.033 Kg	-
Base 14,5x120 cm - 9 mm	5,75 pcs / m ²	4 pcs. / 18,48 Kg	64 boxes / 1183 Kg	-
Base 33x66,5 cm - 10 mm	9 pcs. / m ²	10 pcs. / 25,30 Kg	40 boxes / 1.012 Kg	-
Peldaño recto 120 33x120x3 cm - 12 mm	0,83 pcs. / ml	2 pcs. / 25,90 Kg	11 boxes / 285 Kg	-
Remate peldaño recto 3 x 33 cm	-	20 pcs. / 3,20 Kg	92 boxes / 295 Kg	-
Zanquín ingletado recto* 59,6 x 59,6 cm - 11 mm	-	9 pcs. / 19,80 Kg	56 boxes / 1.110 Kg	-
Rodapié 9x60 cm - 11 mm	1,66 pcs. / ml	18 pcs. / 19,80 Kg	56 boxes / 1.109 Kg	-

ÓPERA	PIEZAS · PIECES · PIÈCES · ЗАПЧАСТИ	CAJAS · BOXES · BOITES · КОРОБКИ	PALETS · PALLETS · PALLETES · ПАЛЛЕТЫ	MEDIDAS DE FABRICACIÓN · MANUFACTURING MEASURES
Base 120x120 cm - 10 mm	0,69 pcs / m ²	1 pcs. / 34,35 Kg	38 boxes / 1.306 Kg	1198x1198 mm
Base 120x120 cm - 9 mm	0,69 pcs / m ²	1 pcs. / 31,63 Kg	40 boxes / 1.265 Kg	1198x1198 mm
Base 60x120 cm - 9 mm	1,39 pcs / m ²	2 pcs. / 29,40 Kg	36 boxes / 1.059 Kg	-
Base 14,5x120 cm - 9 mm	5,75 pcs / m ²	4 pcs. / 18,48 Kg	64 boxes / 1183 Kg	-
Base 14,5x120 cm - 10 mm	5,75 pcs / m ²	4 pcs. / 17,20 Kg	64 boxes / 1.100 Kg	145x1198 mm
Base 33x66,5 cm - 10 mm	4,50 pcs. / m ²	5 pcs. / 25 Kg	40 boxes / 1.000 Kg	-
Peldaño recto 120 33x120x3 cm - 12 mm	0,83 pcs / ml	2 pcs. / 25,90 Kg	11 boxes / 285 Kg	-
Remate peldaño recto 3 x 33 cm	-	20 pcs. / 3,20 Kg	92 boxes / 294 Kg	-
Zanquín recto izda/dcha 17,5x42,3 cm - 7,5 mm (ivory, light, iron)	-	14 pcs. / 10 Kg	54 boxes / 540 Kg	-
Zanquín ingletado recto* 59,6 x 59,6 cm - 11 mm (silver)	-	9 pcs. / 19,80 Kg	56 boxes / 1.109 Kg	-
Rodapié 9x60 cm - 11 mm	1,66 pcs / ml	18 pcs. / 19,80 Kg	56 boxes / 1.109 Kg	-
Borde skimmer 45x75x3 cm - 30 mm	1,33 pcs. / ml	2 pcs. / 30 Kg	29 boxes / 870 Kg	445x750x30mm
Borde desbordante 28x66,5 cm - 30 mm	1,50 pcs. / ml	2 pcs. / 14,47 Kg	72 boxes / 1042 Kg	-
Ángulo desbordante 31x31 cm - 30 mm	-	1 pcs. / 4,01 Kg	92 boxes / 369 Kg	-
Rejilla 24,5x24,5 cm - 30 mm	4 pcs. / ml	6 pcs. / 15,78 Kg	57 boxes / 900 Kg	-
Ángulo rejilla izda/dcha* 33x33 cm - 30 mm	-	1 pcs. / 4,50 Kg	82 boxes / 369 Kg	-
Media caña 4 - 4,2x33 cm	3 pcs. / ml	52 pcs. / 13 Kg	64 boxes / 832 Kg	4,2x33
Uña media caña 4 - 4,2x4,2 cm	-	4 pcs. / 0,40 Kg	200 boxes / 80 Kg	4,2x4,2
Arista 3 - 3,3x33 cm	3 pcs. / ml	70 pcs. / 13 Kg	64 boxes / 832 Kg	3,3x33
Uña arista 3 - 3,3x3,3 cm	-	4 pcs. / 0,40 Kg	72 boxes / 30 Kg	3,3x3,3

* Set de dos piezas / Set of two tiles / Set de deux pièces / Набор из двух штук.

Embalaje.

Packing. Emballage. Упаковка.

URBAN]

MEDITERRÁNEO	PIEZAS · PIECES · PIÈCES · ЗАПЧАСТИ	CAJAS · BOXES · BOITES · КОРОБКИ	PALETS · PALLETS · PALLETES · ПАЛЛЕТЫ	MEDIDAS DE FABRICACIÓN· MANUFACTURING MEASURES
Base 33 x 33 cm - 10 mm	9 pcs. / m ²	9 pcs. / 22,18 Kg	52 boxes / 1.153 Kg	-
Base 33x66,5 cm - 10 mm	4,50 pcs. / m ²	5 pcs. / 25 Kg	40 boxes / 1.000 Kg	-
Rodapié 9x33 cm - 11 mm	3 pcs. / ml	24 pcs. / 13,92 Kg	68 boxes / 947 Kg	-
Vierteaguas 12x33x3 cm - 12 mm	3 pcs. / ml	16 pcs. / 18,05 Kg	52 boxes / 938 Kg	-
Peldaño fiorentino 33x33x3 cm - 12 mm	3 pcs. / ml	4 pcs. / 13,64 Kg	56 boxes / 764 Kg	-
Cartabón fiorentino 33x33x3 cm - 14 mm	-	1 pcs. / 4,8 Kg	92 boxes / 442 Kg	-
Zanquín fiorentino izda/dcha 17,5x39,5 cm (grafito)	-	14 pcs. / 10 Kg	54 boxes / 540 Kg	-
Zanquín ingletado fiorentino izda/dcha* 32,8x32,8 cm - 7,5 mm (arena)	-	12 pcs. / 16,66 Kg	68 boxes / 1.132 Kg	-
Peldaño recto 33x33x3 cm - 12 mm	3 pcs. / ml	4 pcs. / 12,04 Kg	56 boxes / 674 Kg	-
Zanquín recto izda./dcha 17,5x42,3 - 7,5 mm	-	14 pcs. / 10 Kg	54 boxes / 540 Kg	-
Zanquín ingletado recto 32,8x32,8 cm - 11 mm	-	12 pc. / 16,67 Kg	68 boxes / 1.133 Kg	-
Pasamanos 12 12,5x66,5x4 cm	1,50 pcs. / ml	5 pcs. / 18,80 Kg	26 boxes / 489 Kg	-
Pasamanos 15 15,5x66,5x4 cm	1,50 pcs. / ml	5 pcs. / 21,45 Kg	20 boxes / 430 Kg	-

* Set de dos piezas / Set of two tiles / Set de deux pièces / Набор из двух штук.

STONE]

BEDFORD	PIEZAS · PIECES · PIÈCES · ЗАПЧАСТИ	CAJAS · BOXES · BOITES · КОРОБКИ	PALETS · PALLETS · PALLETES · ПАЛЛЕТЫ	MEDIDAS DE FABRICACIÓN· MANUFACTURING MEASURES
Base 120x120 cm - 9 mm	0,69 pcs / m ²	1 pcs. / 34,35 Kg	40 boxes / 1.374 Kg	1198x1198 mm
Base 60x120 cm - 9,2 mm	1,39 pcs / m ²	2 pcs. / 29,80 Kg	33 boxes / 954 Kg	598x1198 mm
Base 14,5x120 cm - 9,2 mm	5,75 pcs / m ²	4 pcs. / 17,20 Kg	64 boxes / 1.100 Kg	145x1198 mm
Base 33x66,5 cm - 10 mm	4,56 pcs. / m ²	5 pcs. / 25,38 Kg	40 boxes / 1.015 Kg	-
Base 33x33 cm - 10 mm	9,18 pcs. / m ²	9 pcs. / 22,18 Kg	52 boxes / 1.153 Kg	-
Peldaño recto 120 33x120x3 cm - 12 mm	0,83 pcs / ml	2 pcs. / 24,40 Kg	11 boxes / 268 Kg	-
Remate peldaño recto 3 x 33 cm	-	20 pcs. / 3,20 Kg	92 boxes / 294 Kg	-
Zanquín ingletado recto 59,6x59,6 cm - 11 mm	-	9 pcs. / 19,80 Kg	56 boxes / 1.010 Kg	-
Rodapié 9x60 cm - 11 mm	1,66 pcs / ml	18 pcs. / 19,80 Kg	56 boxes / 1.109 Kg	-
Borde skimmer 45x120x3 cm	-	-	-	445x1200x30mm
Borde desbordante 28x66,5 cm - 30 mm	1,50 pcs. / ml	2 pcs. / 14,47 Kg	72 boxes / 1042 Kg	-
Ángulo desbordante 31x31 cm - 30 mm	-	1 pcs. / 4,30 Kg	92 boxes / 396 Kg	-
Ángulo rejilla modular 30x30 cm - 30 mm	-	-	-	-
Rejilla modular 24,5x30 cm - 30 mm	-	-	-	4,2x33
Media caña 8 - 7,7x66,5 cm	-	-	-	4,2x33
Uña media caña 8 - 7,7x7,7 cm	-	-	-	4,2x4,2
Arista 8 - 7,7x66,5 cm	-	-	-	3,3x33
Uña arista 8 - 7,7x7,7 cm	-	-	-	3,3x3,3
Ángulo arista 8 - 7,7x7,7x11 cm	-	-	-	-
Ángulo media caña 8 - 7,7x7,7x11 cm	-	-	-	-

ARDENAS	PIEZAS · PIECES · PIÈCES · ЗАПЧАСТИ	CAJAS · BOXES · BOITES · КОРОБКИ	PALETS · PALLETS · PALLETES · ПАЛЛЕТЫ	MEDIDAS DE FABRICACIÓN· MANUFACTURING MEASURES
Base 120x120 cm - 11 mm	0,69 pcs / m ²	1 pcs. / 37,10 Kg	38 boxes / 1.410 Kg	-
Base 60x120 cm - 9 mm	1,39 pcs / m ²	2 pcs. / 29,40 Kg	36 boxes / 1.059 Kg	-
Base 14,5x120 cm - 9 mm	5,75 pcs / m ²	4 pcs. / 18,48 Kg	64 boxes / 1.183 Kg	-
Base 60x120 cm - 20 mm espesorado	1,39 pcs / m ²	1 pcs. / 32,80 Kg	35 boxes / 1.148 Kg	-
Base 33x66,5 cm - 10 mm	4,56 pcs. / m ²	5 pcs. / 25 Kg	40 boxes / 1.000 Kg	-
Base 33x33cm - 10 mm	9 pcs. / m ²	9 pcs. / 22,18 Kg	52 boxes / 1.153 Kg	-
Base 16,25x33 cm - 10 mm	18 pcs. / m ²	18,65 pcs. / 22,50 Kg	56 boxes / 1.260 Kg	-
Base 16,25x16,25 cm - 10 mm	37,81 pcs. / m ²	18 pcs. / 11,16 Kg	112 boxes / 1.250 Kg	-
Peldaño recto 120 33x120x3 cm - 12 mm	0,83 pcs / ml	2 pcs. / 25,90 Kg	11 boxes / 285 Kg	-
Remate peldaño recto 3 x 33 cm	-	20 pcs. / 3,20 Kg	92 boxes / 295 Kg	-
Peldaño ML 33x33x4 cm - 13 mm	3 pcs / ml	4 pcs. / 14,28 Kg	44 boxes / 628 Kg	-
Cartabón ML 33x33x4 cm - 14 mm	-	1 pcs. / 4,31 Kg	92 boxes / 397 Kg	-
Zanquín ingletado recto* 59,6 x 59,6 cm - 11 mm	-	9 pcs. / 19,80 Kg	56 boxes / 1.110 Kg	-
Zanquín ingletado ML izda./dcha.* 59,6 x 59,6 cm izda/dcha - 11 mm	-	9 pcs. / 19,80 Kg	56 boxes / 1.110 Kg	-
Rodapié 9x60 cm - 11 mm	1,66 pcs. / ml	18 pcs. / 19,80 Kg	56 boxes / 1.109 Kg	-
Borde skimmer 45x75x3 cm - 30 mm	1,33 pcs. / ml	2 pcs. / 30 Kg	29 boxes / 870 Kg	445x750x30mm

* Set de dos piezas / Set of two tiles / Set de deux pièces / Набор из двух штук.

Embalaje.

Packing. Emballage. Упаковка.

STONE]

ALBAROC	PIEZAS · PIECES · PIÈCES · ЗАПЧАСТИ	CAJAS · BOXES · BOITES · КОРОБКИ	PALETS · PALLETS · PALLETES · ПАЛЛЕТЫ	MEDIDAS DE FABRICACIÓN · MANUFACTURING MEASURES
Base 100x100 cm - 10 mm	1 pcs / m ²	2 pcs. / 44,26 Kg	24 boxes / 1.102 Kg	-
Base 100x100 cm - 10 mm	1 pcs / m ²	2 pcs. / 48,60 Kg	24 boxes / 1.166 Kg	-
Base 14,5x120 cm - 10,2 mm	5,75 pcs / m ²	4 pcs. / 18,48 Kg	64 boxes / 1.195 Kg	-
Base 33x66,5 cm - 10 mm	4,50 pcs. / m ²	5 pcs. / 25 Kg	40 boxes / 1.000 Kg	-
Base 33 x 33 cm - 10 mm	9 pcs. / m ²	9 pcs. / 22,18 Kg	52 boxes / 1.153 Kg	-
Peldaño ML 33x33x4 cm - 13 mm	3 pcs. / ml	4 pcs. / 14,24 Kg	44 boxes / 627 Kg	-
Cartabón ML 33x33x4 cm - 14 mm	-	1 pcs. / 4,31 Kg	92 boxes / 397 Kg	-
Zanquín ML izda/dcha 18x40 cm - 15 mm	-	6 pcs. / 15 Kg	57 boxes / 855 Kg	-
Peldaño recto 120 33x120x3 cm - 12 mm	0,83 pcs / ml	2 pcs. / 24,40 Kg	11 boxes / 268 Kg	-
Remate peldaño recto 3 x 33 cm	-	20 pcs. / 3,20 Kg	82 boxes / 263 Kg	-
Zanquín recto 18x40 cm - 15 mm	-	6 pcs. / 15 Kg	57 boxes / 855 Kg	-
Pasamanos 12 12,5x66,5x4 cm	1,50 pcs. / ml	5 pcs. / 18,80 Kg	26 boxes / 489 Kg	-
Pasamanos 15 15,5x66,5x4 cm	1,50 pcs. / ml	5 pcs. / 21,45 Kg	20 boxes / 430 Kg	-
Rodapié 9x40 cm - 15 mm	2,50 pcs. / ml	12 pcs. / 14,40 Kg	66 boxes / 950 Kg	-

LITOS	PIEZAS · PIECES · PIÈCES · ЗАПЧАСТИ	CAJAS · BOXES · BOITES · КОРОБКИ	PALETS · PALLETS · PALLETES · ПАЛЛЕТЫ	MEDIDAS DE FABRICACIÓN · MANUFACTURING MEASURES
Base 100x100 cm - 10 mm	1 pcs / m ²	2 pcs. / 50 Kg	24 boxes / 1.200 Kg	-
Base 60x120 cm - 10 mm	1,39 pcs / m ²	2 pcs. / 34 Kg	32 boxes / 1.080 Kg	-
Base 60x120 cm - 9 mm	1,39 pcs / m ²	2 pcs. / 29,40 Kg	36 boxes / 1.059 Kg	-
Base 14,5x120 cm - 10 mm	5,75 pcs / m ²	4 pcs. / 18,48 Kg	64 boxes / 1.183 Kg	-
Base 14,5x120 cm - 9 mm	5,75 pcs / m ²	4 pcs. / 18,48 Kg	64 boxes / 1.183 Kg	-
Base 33x66,5 cm - 10 mm	4,50 pcs. / m ²	5 pcs. / 25 Kg	40 boxes / 1.000 Kg	-
Peldaño recto 120 33x120x3 cm - 12 mm	0,83 pcs / ml	2 pcs. / 24,40 Kg	11 boxes / 268 Kg	-
Remate peldaño recto 3 x 33 cm	-	20 pcs. / 3,20 Kg	92 boxes / 294 Kg	-
Zanquín recto 18x40 cm - 15 mm	-	6 pcs. / 15 Kg	57 boxes / 855 Kg	-
Rodapié 9x40 cm - 15 mm	2,50 pcs. / ml	12 pcs. / 14,40 Kg	66 boxes / 950 Kg	-
Borde desbordante 28x66,5 cm - 30 mm	1,50 pcs. / ml	2 pcs. / 14,47 Kg	72 boxes / 1042 Kg	-
Ángulo desbordante 31x31 cm - 30 mm	-	1 pcs. / 4,01 Kg	92 boxes / 369 Kg	-
Rejilla 24,5x24,5 cm - 30 mm	4 pcs. / ml	6 pcs. / 15,78 Kg	57 boxes / 900 Kg	-
Ángulo rejilla izda/dcha* 33x33 cm - 30 mm	-	1 pcs. / 4,50 Kg	82 boxes / 369 Kg	-
Media caña 4 - 4,2x33 cm	3 pcs. / ml	52 pcs. / 13 Kg	64 boxes / 832 Kg	4,2x33
Uña media caña 4 - 4,2x4,2 cm	-	4 pcs. / 0,40 Kg	200 boxes / 80 Kg	4,2x4,2
Arista 3 - 3,3x33 cm	3 pcs. / ml	70 pcs. / 11,90 Kg	64 boxes / 762 Kg	3,3x33
Uña arista 3 - 3,3x3,3 cm	-	4 pcs. / 0,40 Kg	200 boxes / 80 Kg	3,3x3,3

* Set de dos piezas / Set of two tiles / Set de deux pièces / Набор из двух штук.

MANHATTAN	PIEZAS · PIECES · PIÈCES · ЗАПЧАСТИ	CAJAS · BOXES · BOITES · КОРОБКИ	PALETS · PALLETS · PALLETES · ПАЛЛЕТЫ	MEDIDAS DE FABRICACIÓN · MANUFACTURING MEASURES
Base 24,5x24,5 cm - 9 mm	16 pcs. / m ²	16 pcs. / 19,79 Kg	69 boxes / 1.365 Kg	-
Base 12x24,5 cm - 9 mm	32 pcs. / m ²	35 pcs. / 19,25 Kg	70 boxes / 1.482 Kg	-
Base 12x24,5 cm - 9 mm	32 pcs. / m ²	36 pcs. / 19,25 Kg	63 boxes / 1.213 Kg	-
Listelo 5,75x24,5 cm - 9 mm (doble)	64 pcs. / m ²	72 pcs. / 18,25 Kg	63 boxes / 1.150 Kg	-
Rodapié 9x24,5 cm - 11 mm	4 pcs. / ml	32 pcs. / 12,01 Kg	77 boxes / 925 Kg	-
Vierteaguas 15x24,5x4 cm - 10 mm	4 pcs. / ml	8 pcs. / 7 Kg	78 boxes / 546 Kg	-
Peldaño ML 24,5x33x4 cm - 13 mm	4 pcs. / ml	4 pcs. / 10 Kg	66 boxes / 660 Kg	-
Cartabón ML 33x33x4 cm - 14 mm	-	1 pcs. / 4,31 Kg	92 boxes / 397 Kg	-
Zanquín ML izda/dcha 17,5x39,5 cm - 7,5 mm	-	14 pcs. / 10 Kg	54 boxes / 540 Kg	-

VEGA	PIEZAS · PIECES · PIÈCES · ЗАПЧАСТИ	CAJAS · BOXES · BOITES · КОРОБКИ	PALETS · PALLETS · PALLETES · ПАЛЛЕТЫ	MEDIDAS DE FABRICACIÓN · MANUFACTURING MEASURES
Base 33 x 33 cm - 10 mm	9 pcs. / m ²	9 pcs. / 22,18 Kg	52 boxes / 1.153 Kg	-
Rodapié 9x33 cm - 11 mm	3 pcs. / ml	24 pcs. / 13,92 Kg	68 boxes / 947 Kg	-
Peldaño fiorentino 33x33x3 cm - 12 mm	3 pcs. / ml	4 pcs. / 12,49 Kg	56 boxes / 700 Kg	-
Cartabón fiorentino 33x33x3 cm - 14 mm	-	1 pcs. / 4,80 Kg	92 boxes / 442 Kg	-
Zanquín fiorentino izda/dcha 17,5x39,5 - 7,5 mm (ocre / visión / gris)	-	14 pcs. / 10 Kg	54 boxes / 540 Kg	-
Zanquín Ingletado fiorentino izda/dcha* 32,8x32,8 cm - 11 mm (rojo)	-	12 pcs. / 13,92 Kg	68 boxes / 947 Kg	-
Vierteaguas 12x33x3 cm - 12 mm	3 pcs. / ml	16 pcs. / 18,05 Kg	52 boxes / 938Kg	-

* Set de dos piezas / Set of two tiles / Set de deux pièces / Набор из двух штук.

Embalaje.

Packing. Emballage. Упаковка.

EARTH]

PROVENZA	PIEZAS · PIECES · PIÈCES · ЗАПЧАСТИ	CAJAS · BOXES · BOITES · КОРОБКИ	PALETS · PALLETS · PALLETES · ПАЛЛЕТЫ	MEDIDAS DE FABRICACIÓN · MANUFACTURING MEASURES
Base 120x120 cm - 10 mm	0,69 pcs / m ²	1 pcs. / 34,35 Kg	40 boxes / 1.374 Kg	1198x1198 mm
Base 60x120 cm - 10 mm	1,39 pcs / m ²	2 pcs. / 29,80 Kg	33 boxes / 983 Kg	598x1198 mm
Base 14,5x120 cm - 10 mm	5,75 pcs / m ²	4 pcs. / 18,48 Kg	64 boxes / 1183 Kg	-
Base 33x33 cm - 10 mm	9 pcs. / m ²	9 pcs. / 22,18 Kg	52 boxes / 1.153 Kg	-
Base 16,25X33 cm - 10 mm	18 pcs. / m ²	18 pcs. / 22,50 Kg	56 boxes / 1.260 Kg	-
Base 16,25X16,25 cm - 10 mm	36 pcs. / m ²	18 pcs. / 11,16 Kg	112 boxes / 1.250 Kg	-
Peldaño recto 120 33x120x3 cm - 12 mm	0,83 pcs / ml	2 pcs. / 24,40 Kg	11 boxes / 268 Kg	-
Remate peldaño recto 3 x 33 cm	-	20 pcs. / 3,20 Kg	92 boxes / 295 Kg	-
Zanquin ingletado recto* 59,6 x 59,6 cm - 11 mm	-	9 pcs. / 19,80 Kg	56 boxes / 1.109 Kg	-
Zanquin ingletado ML izda/dcha* 59,6 x 59,6 cm - 11 mm	-	9 pcs. / 19,80 Kg	56 boxes / 1.109 Kg	-
Peldaño ML 33x33x4 cm - 13 mm	3 pcs / ml	4 pcs. / 14,28 Kg	44 boxes / 628 Kg	-
Cartabón fiorentino 33x33x3 cm - 14 mm	-	1 pcs. / 4,31 Kg	92 boxes / 397 Kg	-
Peldaño recto 33x33x3 cm - 12 mm	3 pcs. / ml	4 pcs. / 12,04 Kg	56 boxes / 674 Kg	-
Rodapié 9x60 cm - 11 mm	1,66 pcs / ml	18 pcs. / 19,80 Kg	56 boxes / 1.109 Kg	-
Borde skimmer 45x120x3 cm - 30mm	-	-	-	445x750x30mm
Borde desbordante 28x66,5 cm - 30 mm	1,50 pcs. / ml	2 pcs. / 14,47 Kg	72 boxes / 1042 Kg	-
Ángulo desbordante 31x31 cm - 30 mm	-	1 pcs. / 4,30 Kg	92 boxes / 396 Kg	-
Ángulo rejilla modular 30x30 cm - 30 mm	-	-	-	-
Rejilla modular 24,5x30 cm - 30 mm	-	-	-	-

PORTLAND	PIEZAS · PIECES · PIÈCES · ЗАПЧАСТИ	CAJAS · BOXES · BOITES · КОРОБКИ	PALETS · PALLETS · PALLETES · ПАЛЛЕТЫ	MEDIDAS DE FABRICACIÓN · MANUFACTURING MEASURES
Base 33 x 33 cm - 10 mm	9 pcs. / m ²	9 pcs. / 22,18 Kg	52 boxes / 1.153Kg	-
Peldaño ML 33x33x4 cm - 13 mm	3 pcs. / ml	4 pcs. / 14,28 Kg	44 boxes / 628 Kg	-
Cartabón fiorentino 33x33x3 cm - 14 mm	-	1 pcs. / 4,31 Kg	92 boxes / 397 Kg	-

* Set de dos piezas / Set of two tiles / Set de deux pièces / Набор из двух штук.

ALHAMAR	PIEZAS · PIECES · PIÈCES · ЗАПЧАСТИ	CAJAS · BOXES · BOITES · КОРОБКИ	PALETS · PALLETS · PALLETES · ПАЛЛЕТЫ	MEDIDAS DE FABRICACIÓN · MANUFACTURING MEASURES
Base 33 x 33 cm - 10 mm	9 pcs. / m ²	9 pcs. / 22,18 Kg	52 boxes / 1.153Kg	-
Base 16,25x33 cm - 10 mm	18 pcs. / m ²	18 pcs. / 21,60 Kg	56 boxes / 1.210 Kg	-
Base 16,25x16,25 cm - 10 mm	37,87 pcs. / m ²	18 pcs. / 10,80 Kg	112 boxes / 1.210 Kg	-
Base 16,25x16,25 cm - 10 mm	37,87 pcs. / m ²	36 pcs. / 22,32Kg	56 boxes / 1.250 Kg	-
Rodapié 9x33 cm - 11 mm	3 pcs. / ml	24 pcs. / 13,92 Kg	68 boxes / 947 Kg	-
Peldaño fiorentino 33x33x3 cm - 12 mm	3 pcs. / ml	4 pcs. / 12,49 Kg	56 boxes / 700 Kg	-
Cartabón fiorentino 33x33x3 cm - 14 mm	-	1 pcs. / 4 Kg	92 boxes / 368 Kg	-
Zanquin fiorentino izda/dcha 17,5x39,5 cm - 7,5 mm (blanco/salmón/rojo)	-	14 pcs. / 10 Kg	54 boxes / 540 Kg	-
Zanquin Ingletado fiorentino izda/dcha* 32,8x32,8 cm - 11 mm (paja)	-	12 pcs. / 13,92 Kg	68 boxes / 947 Kg	-
Vierteaguas 15x33x4 cm - 10 mm	3 pcs. / ml	8 pcs. / 10,56 Kg	52 boxes / 550 Kg	-
Decorative / Clay 33 x 33 cm - 10 mm	9 pcs. / m ²	9 pcs. / 22,18 Kg	52 boxes / 1.153 Kg	-
Tabica Clay 15x33 cm - 10 mm	3 pcs. / ml	12 pcs. / 13,20 Kg	82 boxes / 1.083 Kg	-

METAL]

METÁLICA	PIEZAS · PIECES · PIÈCES · ЗАПЧАСТИ	CAJAS · BOXES · BOITES · КОРОБКИ	PALETS · PALLETS · PALLETES · ПАЛЛЕТЫ	MEDIDAS DE FABRICACIÓN · MANUFACTURING MEASURES
Base 33 x 33 cm - 10 mm	9 pcs. / m ²	9 pcs. / 22,18 Kg	52 boxes / 1.153 Kg	-
Rodapié 9x33 cm - 11 mm	3 pcs. / ml	24 pcs. / 13,92 Kg	68 boxes / 947 Kg	-
Peldaño fiorentino 33x33x3 cm - 12 mm	3 pcs. / ml	4 pcs. / 14,28 Kg	44 boxes / 628 Kg	-
Cartabón fiorentino 33x33x3 cm - 14 mm	-	1 pcs. / 4,31 Kg	92 boxes / 397 Kg	-
Zanquin fiorentino izda./dcha 17,5x39,5 cm - 7,5 mm	-	14 pcs. / 10 Kg	54 boxes / 540 Kg	-

* Set de dos piezas / Set of two tiles / Set de deux pièces / Набор из двух штук.

EXAGRES se reserva el derecho de anular, modificar total o parcialmente cualquiera de los colores, formatos, referencias y especificaciones técnicas contenidas en este catálogo. Los colores reproducidos en este catálogo son orientativos y pueden variar respecto a la pieza original. Las medidas y referencias deben verificarse ya que pueden haber errores tipográficos.

EXAGRES reserves the right to partially or totally cancel or modify any of the colours, formats, references and technical specifications contained in this catalogue. The colours reproduced in this catalogue are intended as a guide and may vary in the original piece. Measurements and references should be verified as typographical errors may occur.

EXAGRES se réserve le droit d'annuler, de modifier totalement ou partiellement toutes les couleurs, tous les formats, toutes les références et spécificités techniques contenues dans ce catalogue. Les couleurs reproduites dans ce catalogue sont à titre indicatif et peuvent varier par rapport à la pièce originale. Les mesures et les références doivent être vérifiées car des erreurs typographiques peuvent se produire.

Компания EXAGRES оставляет за собой право отменить или изменить, полностью или частично, любой из цветов, форматов, артикулов, а также технические характеристики, содержащиеся в этом каталоге. Все приведенные в данном каталоге цвета являются приблизительными и могут незначительно отличаться от цвета оригинального изделия. Измерения и ссылки должны быть проверены, так как возможны типографские ошибки.